

 CollegeBoardAP[®]**INCLUDES**

- ✓ Course framework
- ✓ Instructional section
- ✓ Sample exam questions

AP[®] Physics C: Mechanics

COURSE AND EXAM DESCRIPTION

Effective
Fall 2020



AP[®] Physics C: Mechanics

COURSE AND EXAM DESCRIPTION

Effective
Fall 2020

AP COURSE AND EXAM DESCRIPTIONS ARE UPDATED PERIODICALLY

Please visit AP Central (apcentral.collegeboard.org) to determine whether a more recent course and exam description is available.

About College Board

College Board is a mission-driven, not-for-profit organization that connects students to college success and opportunity. Founded in 1900, College Board was created to expand access to higher education. Today, the membership association is made up of over 6,000 of the world's leading educational institutions and is dedicated to promoting excellence and equity in education. Each year, College Board helps more than seven million students prepare for a successful transition to college through programs and services in college readiness and college success—including the SAT® and the Advanced Placement® Program (AP®). The organization also serves the education community through research and advocacy on behalf of students, educators, and schools.

For further information, visit collegeboard.org.

AP Equity and Access Policy

College Board strongly encourages educators to make equitable access a guiding principle for their AP programs by giving all willing and academically prepared students the opportunity to participate in AP. We encourage the elimination of barriers that restrict access to AP for students from ethnic, racial, and socioeconomic groups that have been traditionally underrepresented. Schools should make every effort to ensure their AP classes reflect the diversity of their student population. College Board also believes that all students should have access to academically challenging course work before they enroll in AP classes, which can prepare them for AP success. It is only through a commitment to equitable preparation and access that true equity and excellence can be achieved.

Contents

- v **Acknowledgments**
- 1 **About AP**
- 4 **AP Resources and Supports**
- 6 **Instructional Model**
- 7 **About the AP Physics C: Mechanics Course**
- 7 College Course Equivalent
- 7 Prerequisites
- 7 Laboratory Requirement

COURSE FRAMEWORK

- 11 **Introduction**
- 12 **Course Framework Components**
- 13 Science Practices
- 15 Course Content
- 18 **Course at a Glance**
- 21 **Unit Guides**
- 22 Using the Unit Guides
- 25 **UNIT 1: Kinematics**
- 35 **UNIT 2: Newton's Laws of Motion**
- 47 **UNIT 3: Work, Energy, and Power**
- 61 **UNIT 4: Systems of Particles and Linear Momentum**
- 73 **UNIT 5: Rotation**
- 89 **UNIT 6: Oscillations**
- 99 **UNIT 7: Gravitation**

LABORATORY INVESTIGATIONS

- 111 **Lab Experiments**
- 112 **How to Set Up a Lab Program**

INSTRUCTIONAL APPROACHES

- 117 **Selecting and Using Course Materials**
- 117 **Guided Inquiry in AP Physics C: Mechanics**
- 118 **Instructional Strategies**
- 127 **Developing the Science Practices**

EXAM INFORMATION

- 143 **Exam Overview**
- 149 **Sample Exam Questions**

SCORING GUIDELINES

161 **Question 1**

165 **Question 2**

APPENDIX

171 **Table of Information: Equations**

Acknowledgments

College Board would like to acknowledge the following committee members, consultants, and reviewers for their assistance with and commitment to the development of this course. All individuals and their affiliations were current at the time of contribution.

Judith Adler, *Brentwood School, Los Angeles, CA*

Peggy Bertrand, *University of Tennessee, Knoxville, TN (retired)*

Jesus Hernandez, *Manhattan Center for Science and Mathematics High School, New York, NY*

Beth Lindsey, *Pennsylvania State University-Greater Allegheny, McKeesport, PA*

Tom Masulis, *Shasta College, Redding, CA*

Mackenzie Stetzer, *University of Maine, Orono, ME*

Michelle Strand, *West Fargo High School, West Fargo, ND*

James Vanderweide, *Hudsonville High School, Hudsonville, MI*

Matthew Vonk, *University of Wisconsin-River Falls, River Falls, WI*

Connie Wells, *Rockhurst University, Kansas City, MO*

Shannon Willoughby, *Montana State University, Bozeman, MT*

College Board Staff

Ryan Feuer, *Developmental Editor, AP Curricular Publications*

Amy Johnson, *Director, AP Instructional Design and PD Resource Development*

Trinna Johnson, *Director, AP Curriculum and Content Development*

David Jones, *Director, AP Curriculum and Content Development*

Claire Lorenz, *Senior Director, AP Instructional Design and PD Resource Development*

Daniel McDonough, *Senior Director, AP Content Integration*

Allison Milverton, *Director, AP Curricular Publications*

Tanya Sharpe, *Senior Director, AP Curriculum and Content Development*

SPECIAL THANKS *John R. Williamson*

THIS PAGE IS INTENTIONALLY LEFT BLANK.

About AP

College Board’s Advanced Placement® Program (AP®) enables willing and academically prepared students to pursue college-level studies—with the opportunity to earn college credit, advanced placement, or both—while still in high school. Through AP courses in 38 subjects, each culminating in a challenging exam, students learn to think critically, construct solid arguments, and see many sides of an issue—skills that prepare them for college and beyond. Taking AP courses demonstrates to college admission officers that students have sought the most challenging curriculum available to them, and research indicates that students who score a 3 or higher on an AP Exam typically experience greater academic success in college and are more likely to earn a college degree than non-AP students. Each AP teacher’s syllabus is evaluated and approved by faculty from some of the nation’s leading colleges and universities, and AP Exams are developed and scored by college faculty and experienced AP teachers. Most four-year colleges and universities in the United States grant credit, advanced placement, or both on the basis of successful AP Exam scores; more than 3,300 institutions worldwide annually receive AP scores.

AP Course Development

In an ongoing effort to maintain alignment with best practices in college-level learning, AP courses and exams emphasize challenging, research-based curricula aligned with higher education expectations.

Individual teachers are responsible for designing their own curriculum for AP courses, selecting appropriate college-level readings, assignments, and resources. This course and exam description presents the content and skills that are the focus of the corresponding college course and that appear on the AP Exam. It also organizes the content and skills into a series of units that represent a sequence found in widely adopted college textbooks and that many AP teachers have told us they follow in order to focus their instruction. The intention of this publication is to respect teachers’ time and expertise by providing a roadmap that they can modify and adapt to their local priorities and preferences. Moreover, by organizing the AP course content and skills into units, the AP Program is able to provide teachers and students with free formative

assessments—Personal Progress Checks—that teachers can assign throughout the year to measure student progress as they acquire content knowledge and develop skills.

Enrolling Students: Equity and Access

College Board strongly encourages educators to make equitable access a guiding principle for their AP programs by giving all willing and academically prepared students the opportunity to participate in AP. We encourage the elimination of barriers that restrict access to AP for students from ethnic, racial, and socioeconomic groups that have been traditionally underserved. College Board also believes that all students should have access to academically challenging coursework before they enroll in AP classes, which can prepare them for AP success. It is only through a commitment to equitable preparation and access that true equity and excellence can be achieved.

Offering AP Courses: The AP Course Audit

The AP Program unequivocally supports the principle that each school implements its own curriculum that will enable students to develop the content understandings and skills described in the course framework.

While the unit sequence represented in this publication is optional, the AP Program does have a short list of curricular and resource requirements that must be fulfilled before a school can label a course “Advanced Placement” or “AP.” Schools wishing to offer AP courses must participate in the AP Course Audit, a process through which AP teachers’ course materials are reviewed by college faculty. The AP Course Audit was created to provide teachers and administrators with clear guidelines on curricular and resource requirements for AP courses and to help colleges and universities validate courses marked “AP” on students’ transcripts. This process ensures that AP teachers’ courses meet or exceed the curricular and resource expectations that college and secondary school faculty have established for college-level courses.

The AP Course Audit form is submitted by the AP teacher and the school principal (or designated administrator) to confirm awareness and understanding of the curricular and resource requirements. A syllabus or course outline, detailing how course requirements are met, is submitted by the AP teacher for review by college faculty.

Please visit collegeboard.org/apcourseaudit for more information to support the preparation and submission of materials for the AP Course Audit.

How the AP Program Is Developed

The scope of content for an AP course and exam is derived from an analysis of hundreds of syllabi and course offerings of colleges and universities. Using this research and data, a committee of college faculty and expert AP teachers work within the scope of the corresponding college course to articulate what students should know and be able to do upon the completion of the AP course. The resulting course framework is the heart of this course and exam description and serves as a blueprint of the content and skills that can appear on an AP Exam.

The AP Test Development Committees are responsible for developing each AP Exam, ensuring the exam questions are aligned to the course framework. The AP Exam development process is a multiyear endeavor; all AP Exams undergo extensive review, revision, piloting, and analysis to ensure that questions are accurate, fair, and valid, and that there is an appropriate spread of difficulty across the questions.

Committee members are selected to represent a variety of perspectives and institutions (public and private, small and large schools and colleges), and a range of gender, racial/ethnic, and regional groups. A list of each subject’s current AP Test Development Committee members is available on apcentral.collegeboard.org.

Throughout AP course and exam development, College Board gathers feedback from various stakeholders in both secondary schools and higher education institutions. This feedback is carefully considered to ensure that AP courses and exams are able to provide students with a college-level learning experience and the opportunity to demonstrate their qualifications for advanced placement or college credit.

How AP Exams Are Scored

The exam scoring process, like the course and exam development process, relies on the expertise of both AP teachers and college faculty. While multiple-choice questions are scored by machine,

the free-response questions and through-course performance assessments, as applicable, are scored by thousands of college faculty and expert AP teachers. Most are scored at the annual AP Reading, while a small portion are scored online. All AP Readers are thoroughly trained, and their work is monitored throughout the Reading for fairness and consistency. In each subject, a highly respected college faculty member serves as Chief Faculty Consultant and, with the help of AP Readers in leadership positions, maintains the accuracy of the scoring standards. Scores on the free-response questions and performance assessments are weighted and combined with the results of the computer-scored multiple-choice questions, and this raw score is converted into a composite AP score on a 1–5 scale.

AP Exams are **not** norm-referenced or graded on a curve. Instead, they are criterion-referenced, which means that every student who meets the criteria for an AP score of 2, 3, 4, or 5 will receive that score, no matter how many students that is. The criteria for the number of points students must earn on the AP Exam to receive scores of 3, 4, or 5—the scores that research consistently validates for credit and placement purposes—include:

- The number of points successful college students earn when their professors administer AP Exam questions to them.
- The number of points researchers have found to be predictive that an AP student will succeed when placed into a subsequent, higher-level college course.
- Achievement-level descriptions formulated by college faculty who review each AP Exam question.

Using and Interpreting AP Scores

The extensive work done by college faculty and AP teachers in the development of the course and exam and throughout the scoring process ensures that AP Exam scores accurately represent students’ achievement in the equivalent college course. Frequent and regular research studies establish the validity of AP scores as follows:

AP Score	Credit Recommendation	College Grade Equivalent
5	Extremely well qualified	A
4	Well qualified	A–, B+, B
3	Qualified	B–, C+, C
2	Possibly qualified	n/a
1	No recommendation	n/a

While colleges and universities are responsible for setting their own credit and placement policies, most private colleges and universities award credit and/or advanced placement for AP scores of 3 or higher. Additionally, most states in the United States have adopted statewide credit policies that ensure college credit for scores of 3 or higher at public colleges and universities. To confirm a specific college's AP credit/placement policy, a search engine is available at apstudent.org/creditpolicies.

BECOMING AN AP READER

Each June, thousands of AP teachers and college faculty members from around the world gather for seven days in multiple locations to evaluate and score the free-response sections of the AP Exams. Ninety-eight percent of surveyed educators who took part in the AP Reading say it was a positive experience.

There are many reasons to consider becoming an AP Reader, including opportunities to:

- **Bring positive changes to the classroom:** Surveys show that the vast majority of returning AP Readers—both high school and college educators—make improvements to the way they

teach or score because of their experience at the AP Reading.

- **Gain in-depth understanding of AP Exam and AP scoring standards:** AP Readers gain exposure to the quality and depth of the responses from the entire pool of AP Exam takers, and thus are better able to assess their students' work in the classroom.
- **Receive compensation:** AP Readers are compensated for their work during the Reading. Expenses, lodging, and meals are covered for Readers who travel.
- **Score from home:** AP Readers have online distributed scoring opportunities for certain subjects. Check collegeboard.org/apreading for details.
- **Earn Continuing Education Units (CEUs):** AP Readers earn professional development hours and CEUs that can be applied to PD requirements by states, districts, and schools.

How to Apply

Visit collegeboard.org/apreading for eligibility requirements and to start the application process.

AP Resources and Supports

By completing a simple activation process at the start of the school year, teachers and students receive access to a robust set of classroom resources.

AP Classroom

AP Classroom is a dedicated online platform designed to support teachers and students throughout their AP experience. The platform provides a variety of powerful resources and tools to provide yearlong support to teachers and enables students to receive meaningful feedback on their progress.



UNIT GUIDES

Appearing in this publication and on AP Classroom, these planning guides outline all required course content and skills, organized into commonly taught units. Each unit guide suggests a sequence and pacing of content, scaffolds skill instruction across units, organizes content into topics, and provides tips on taking the AP Exam.



PERSONAL PROGRESS CHECKS

Formative AP questions for every unit provide feedback to students on the areas where they need to focus. Available online, Personal Progress Checks measure knowledge and skills through multiple-choice questions with rationales to explain correct and incorrect answers, and free-response questions with scoring information. Because the Personal Progress Checks are formative, the results of these assessments cannot be used to evaluate teacher effectiveness or assign letter grades to students, and any such misuses are grounds for losing school authorization to offer AP courses.*



PROGRESS DASHBOARD

This dashboard allows teachers to review class and individual student progress throughout the year. Teachers can view class trends and see where students struggle with content and skills that will be assessed on the AP Exam. Students can view their own progress over time to improve their performance before the AP Exam.



AP QUESTION BANK

This online library of real AP Exam questions provides teachers with secure questions to use in their classrooms. Teachers can find questions indexed by course topics and skills, create customized tests, and assign them online or on paper. These tests enable students to practice and get feedback on each question.

* To report misuses, please call 877-274-6474 (International: +1-212-632-1781).

Digital Activation

In order to teach an AP class and make sure students are registered to take the AP Exam, teachers must first complete the digital activation process. Digital activation gives students and teachers access to resources and gathers students' exam registration information online, eliminating most of the answer sheet bubbling that has added to testing time and fatigue.

AP teachers and students begin by signing in to **My AP** and completing a simple activation process at the start of the school year, which provides access to all AP resources, including AP Classroom.

To complete digital activation:

- Teachers and students sign in to, or create, their College Board accounts.
- Teachers confirm that they have added the course they teach to their AP Course Audit account and have had it approved by their school's administrator.
- Teachers or AP Coordinators, depending on who the school has decided is responsible, set up class sections so students can access AP resources and have exams ordered on their behalf.
- Students join class sections with a join code provided by their teacher or AP coordinator.
- Students will be asked for additional registration information upon joining their first class section, which eliminates the need for extensive answer sheet bubbling on exam day.

While the digital activation process takes a short time for teachers, students, and AP coordinators to complete, overall it helps save time and provides the following additional benefits:

- **Access to AP resources and supports:** Teachers have access to resources specifically designed to support instruction and provide feedback to students throughout the school year as soon as activation is complete.
- **Streamlined exam ordering:** AP Coordinators can create exam orders from the same online class rosters that enable students to access resources. The coordinator reviews, updates, and submits this information as the school's exam order in the fall.
- **Student registration labels:** For each student included in an exam order, schools will receive a set of personalized AP ID registration labels, which replaces the AP student pack. The AP ID connects a student's exam materials with the registration information they provided during digital activation, eliminating the need for pre-administration sessions and reducing time spent bubbling on exam day.
- **Targeted Instructional Planning Reports:** AP teachers will get Instructional Planning Reports (IPRs) that include data on each of their class sections automatically rather than relying on special codes optionally bubbled in on exam day.

Instructional Model

Integrating AP resources throughout the course can help students develop the science practices, skills, and conceptual understandings. The instructional model outlined below shows possible ways to incorporate AP resources into the classroom.



Plan

Teachers may consider the following approaches as they plan their instruction before teaching each unit.

- Review the overview at the start of each **unit guide** to identify essential questions, conceptual understandings, and skills for each unit.
- Use the **Unit at a Glance** table to identify related topics that build toward a common understanding, and then plan appropriate pacing for students.
- Identify useful strategies in the **Instructional Approaches** section to help teach the concepts and skills.



Teach

When teaching, supporting resources can be used to build students' conceptual understanding and mastery of skills.

- Use the topic pages in the **unit guides** to identify the required content.
- Integrate the content with a skill, considering any appropriate scaffolding.
- Employ any of the instructional strategies previously identified.
- Use the available resources on the topic pages to bring a variety of assets into the classroom.



Assess

Teachers can measure student understanding of the content and skills covered in the unit and provide actionable feedback to students.

- At the end of each unit, use AP Classroom to assign students the online Personal Progress Checks, as homework or an in-class task.
- Provide question-level feedback to students through answer rationales; provide unit- and skill-level feedback using the performance dashboard.
- Create additional practice opportunities using the **AP Question Bank** and assign them through **AP Classroom**.

About the AP Physics C: Mechanics Course

AP Physics C: Mechanics is a calculus-based, college-level physics course. It covers kinematics; Newton's laws of motion; work, energy, and power; systems of particles and linear momentum; circular motion and rotation; oscillations; and gravitation.

College Course Equivalent

It is strongly recommended that AP Physics C: Mechanics be taught as a second-year physics course. A first-year physics course aimed at developing a thorough understanding of important physical principles and that permits students to explore concepts in the laboratory provides a richer experience in the process of science and better prepares them for the more analytical approaches taken in AP Physics C: Mechanics.

However, secondary school programs for the achievement of AP course goals can take other forms as well, and imaginative teachers can design approaches that best fit the needs of their students. In some schools, AP Physics C: Mechanics has been taught successfully as a very intensive first year course; but in this case, there may not be enough time to cover the material in sufficient depth to reinforce the students' conceptual understanding or to provide adequate laboratory experiences. This approach can work for highly motivated, able students but is not generally recommended. Independent study or other first year physics courses supplemented with extra work for individual, motivated students are also possibilities that have been successfully implemented.

If AP Physics C: Mechanics is taught as a second year course, it is recommended that the course meet for at least 250 minutes per week (the equivalent of a 50-minute period every day). However, if it is to be taught as a first year course, approximately 90 minutes per day (450 minutes per week) is recommended in order to devote sufficient time to study the material to an appropriate depth and allow time for labs. In a school that uses block scheduling, one of the AP Physics C courses, but not both, can be taught in a single semester.

Whichever approach is taken, the nature of the AP Physics C: Mechanics course requires teachers to spend time on the extra preparation needed for both class and laboratory. AP teachers should have a teaching load that is adjusted accordingly.

Prerequisites

Students should have taken or be concurrently taking calculus.

Laboratory Requirement

AP Physics C: Mechanics should include a hands-on laboratory component comparable to a semester-long introductory college-level physics laboratory. Students should spend a minimum of 25% of instructional time engaged in hands-on laboratory work. Students ask questions, make observations and predictions, design experiments, analyze data, and construct arguments in a collaborative setting, where they direct and monitor their progress. Each student should complete a lab notebook or portfolio of lab reports.

THIS PAGE IS INTENTIONALLY LEFT BLANK.

AP PHYSICS C: MECHANICS

Course Framework

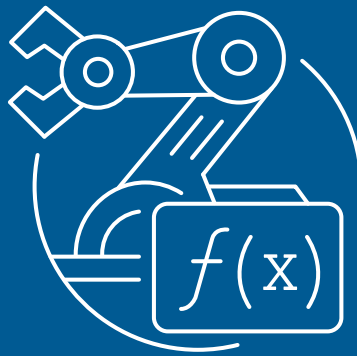

Introduction

The AP Physics C: Mechanics course outlined in this framework reflects a commitment to what physics teachers, professors, and researchers have agreed is the main goal of a college-level physics course: to help students develop a deep understanding of the foundational principles that shape classical mechanics. By confronting complex physical situations or scenarios, the course is designed to enable students to develop the ability to reason about physical phenomena using important science practices, such as creating and analyzing representations of physical scenarios, designing experiments, analyzing data, and using mathematics to model and to solve problems.

To foster this deeper level of learning, the AP Physics C: Mechanics course defines concepts, skills, and understandings required by representative colleges and universities for granting college credit and placement. Students will practice reasoning skills used by physicists by discussing and debating, with peers, the physical phenomena investigated in class, as well as by designing and conducting inquiry-based laboratory investigations to solve problems through first-hand observations, data collection, analysis, and interpretation.

This document is not a complete curriculum. Teachers create their own local curriculum by selecting, for each concept, content that enables students to explore the course learning objectives and meets state or local requirements. This result is a course that prepares students for college credit and placement.

Course Framework Components

Overview

This course framework provides a clear and detailed description of the course requirements necessary for student success. The framework specifies what students must know, be able to do, and understand to qualify for college credit or placement.

The course framework includes two essential components:

1 SCIENCE PRACTICES

The science practices are central to the study and practice of physics. Students should develop and apply the described science practices on a regular basis over the span of the course.

2 COURSE CONTENT

The course content is organized into commonly taught units of study that provide a suggested sequence for the course and detail required content and conceptual understandings that colleges and universities typically expect students to master to qualify for college credit and/or placement. This content is grounded in big ideas, which are cross-cutting concepts that build conceptual understanding and spiral throughout the course.

1**AP PHYSICS C: MECHANICS**

Science Practices

The table that follows presents the science practices that students should develop and practice during the AP Physics C: Mechanics course. These practices, and their related skills, form the basis of many tasks on the AP Physics C: Mechanics Exam.

The unit guides that follow embed and spiral these science practices throughout the course, providing teachers with one way to integrate the skills into the course content with sufficient repetition to prepare students to transfer those skills when taking the AP Physics C: Mechanics Exam.

More detailed information about teaching the science practices can be found in the Instructional Approaches section of this publication.

**Practice 1****Visual Representations****1**

Analyze and/or use [non-narrative/[non-mathematical] representations of physical situations, excluding graphs.

Practice 2**Question and Method****2**

Determine scientific questions and methods.

Practice 3**Representing Data and Phenomena****3**

Create visual representations or models of physical situations.

Practice 4**Data Analysis****4**

Analyze quantitative data represented in graphs.

Practice 5**Theoretical Relationships****5**

Determine the effects on a quantity when another quantity or the physical situation changes.

Practice 6**Mathematical Routines****6**

Solve problems of physical situations using mathematical relationships.

Practice 7**Argumentation****7**

Develop an explanation or a scientific argument.

SKILLS

1.A Describe the physical meaning (includes identifying features) of a representation.

1.B Describe the relationship between different types of representations of the same physical situation.

1.C Demonstrate consistency between different types of representations of the same physical situation.

1.D Select relevant features of a representation to answer a question or solve a problem.

1.E Describe the effects of modifying conditions or features of a representation of a physical situation.

2.A Identify a testable scientific question or problem.

2.B Make a claim or predict the results of an experiment.

2.C Identify appropriate experimental procedures (which may include a sketch of a lab setup).

2.D Make observations or collect data from representations of laboratory setups or results.

2.E Identify or describe potential sources of experimental error.

2.F Explain modifications to an experimental procedure that will alter results.

3.A Select and plot appropriate data.

3.B Represent features of a model or the behavior of a physical system using appropriate graphing techniques, appropriate scale, and units.

3.C Sketch a graph that shows a functional relationship between two quantities.

3.D Create appropriate diagrams to represent physical situations.

4.A Identify and describe patterns and trends in data or a graph.

4.B Demonstrate consistency between different graphical representations of the same physical situation.

4.C Linearize data and/or determine a best fit line or curve.

4.D Select relevant features of a graph to describe a physical situation or solve problems.

4.E Explain how the data or graph illustrates a physics principle, process, concept, or theory.

5.A Select an appropriate law, definition, mathematical relationship, or model to describe a physical situation.

5.B Determine the relationship between variables within an equation when an existing variable changes.

5.C Determine the relationship between variables within an equation when a new variable is introduced.

5.D Determine or estimate the change in a quantity using a mathematical relationship.

5.E Derive a symbolic expression from known quantities by selecting and following a logical algebraic pathway.

6.A Extract quantities from narratives or mathematical relationships to solve problems.

6.B Apply an appropriate law, definition, or mathematical relationship to solve a problem.

6.C Calculate an unknown quantity with units from known quantities by selecting and following a logical computational pathway.

6.D Assess the reasonableness of results or solutions.

7.A Make a scientific claim.

7.B Support a claim with evidence from experimental data.

7.C Support a claim with evidence from physical representations.

7.D Provide reasoning to justify a claim using physical principles or laws.

7.E Explain the connection between experimental results and larger physical principles, laws, or theories.

7.F Explain how potential sources of experimental error may affect results and/or conclusions.

2

AP PHYSICS C: MECHANICS

Course Content

Based on the Understanding by Design® (Wiggins and McTighe) model, this course framework provides a clear and detailed description of the course requirements necessary for student success. The framework specifies what students must know, be able to do, and understand, with a focus on big ideas that encompass core principles, theories, and processes of the discipline. The framework also encourages instruction that prepares students to make connections across domains through a broader way of thinking about the physical world.

Big Ideas

The big ideas serve as the foundation of the course and develop understanding as they spiral throughout the course. The big ideas enable students to create meaningful connections among course concepts. Often, these big ideas are abstract concepts or themes that become threads that run throughout the course. Revisiting the big ideas and applying them in a variety of contexts allow students to develop deeper conceptual understanding. Following are the big ideas of the course and a brief description of each:

BIG IDEA 1: CHANGE (CHA)

Interactions produce changes in motion.

BIG IDEA 2: FORCE INTERACTIONS (INT)

Forces characterize interactions between objects or systems.

BIG IDEA 3: FIELDS (FLD)

Fields predict and describe interactions.

BIG IDEA 4: CONSERVATION (CON)

Conservation laws constrain interactions.

UNITS

The course content is organized into commonly taught units. The units have been arranged in a logical sequence frequently found in many college courses and textbooks.

The seven units in AP Physics C: Mechanics, and their weightings on the multiple-choice section of AP Exam, are listed below.

Pacing recommendations at the unit level and on the Course at a Glance provide suggestions for how teachers can teach the required course content and administer the Personal Progress Checks. The suggested class periods are based on a schedule in

which the class meets five days a week for 45 minutes each day. While these recommendations have been made to aid in planning, teachers are free to adjust the pacing based on the needs of their students, alternate schedules (e.g., block scheduling), or their school's academic calendar.

TOPICS

Each unit is divided into teachable segments called topics. Visit the topic pages (starting on p. 30) to see all required content for each topic. Although most topics can be taught in one or two class periods, teachers are again encouraged to pace their course to suit the needs of their students and school.

Exam Weighting for the Multiple-Choice Section of the AP Exam

Units	Exam Weighting
Unit 1: <i>Kinematics</i>	14–20%
Unit 2: <i>Newton's Laws of Motion</i>	17–23%
Unit 3: <i>Work, Energy, and Power</i>	14–17%
Unit 4: <i>Systems of Particles and Linear Momentum</i>	14–17%
Unit 5: <i>Rotation</i>	14–20%
Unit 6: <i>Oscillations</i>	6–14%
Unit 7: <i>Gravitation</i>	6–14%

Spiraling the Big Ideas

The following table shows how the big ideas spiral across units by showing the units in which each big idea appears.

Big Ideas		Enduring Understandings						
		Unit 1: Kinematics	Unit 2: Newton's Laws of Motion	Unit 3: Work, Energy, and Power	Unit 4: Systems of Particles and Linear Momentum	Unit 5: Rotation	Unit 6: Oscillations	Unit 7: Gravitation
Change CHA		✓			✓	✓		
Force Interactions INT			✓	✓	✓	✓	✓	
Fields FLD								✓
Conservation CON								✓

Course at a Glance

Plan

The course at a glance provides a useful visual organization of the AP Physics C: Mechanics curricular components, including:

- Sequence of units, along with approximate weighting and suggested pacing. Please note, pacing options are provided for teaching the course in a single semester or a full year.
- Progression of topics within each unit.
- Spiraling of the big ideas and skills across units

Teach

SCIENCE PRACTICES

Science practices are spiraled throughout the course.

- | | |
|--|------------------------------------|
| 1 Visual Representations | 4 Data Analysis |
| 2 Question and Method | 5 Theoretical Relationships |
| 3 Representing Data and Phenomena | 6 Mathematical Routines |
| | 7 Argumentation |

+ Indicates 3 or more skills/practices suggested for a given topic. The individual topic page will show all the suggested skills.

BIG IDEAS

Big Ideas spiral across topics and units.

- | | |
|-------------------------------|-------------------------|
| CHA Change | FLD Fields |
| INT Force Interactions | CON Conservation |

Assess

Assign the Personal Progress Checks—either as homework or in class—for each unit. Each Personal Progress Check contains formative multiple-choice and free-response questions. The feedback from the Personal Progress Checks shows students the areas where they need to focus.

UNIT 1

Kinematics

~11/~22

Class Periods

14–20%

AP Exam Weighting

CHA

+

1.1 Kinematics: Motion in One Dimension

CHA

+

1.2 Kinematics: Motion in Two Dimensions

UNIT 2

Newton's Laws of Motion

~12/~24

Class Periods

17–23%

AP Exam Weighting

INT

+

2.1 Newton's Laws of Motion: First and Second Law

INT

+

2.2 Circular Motion

INT

+

2.3 Newton's Laws of Motion: Third Law

Personal Progress Check 1

Multiple-choice: ~15 questions
Free-response: 1 question

Personal Progress Check 2

Multiple-choice: ~25 questions
Free-response: 1 question

UNIT
3

**Work, Energy,
and Power**

~10/~20 Class Periods **14-17%** AP Exam Weighting

INT 3.1 **Work-Energy Theorem**
2
7

CON 3.2 **Force and Potential Energy**
+

CON 3.3 **Conservation of Energy**
+

CON 3.4 **Power**
5

Personal Progress Check 3

Multiple-choice: ~20 questions
Free-response: 1 question

UNIT
4

**Systems of
Particles and
Linear Momentum**

~10/~20 Class Periods **14-17%** AP Exam Weighting

CHA 4.1 **Center of Mass**
6

INT 4.2 **Impulse and Momentum**
+

CON 4.3 **Conservation of Linear Momentum, Collisions**
+

Personal Progress Check 4

Multiple-choice: ~15 questions
Free-response: 1 question

UNIT
5

Rotation

~10/~20 Class Periods **14-20%** AP Exam Weighting

INT 5.1 **Torque and Rotational Statics**
2
3

CHA 5.2 **Rotational Kinematics**
5
6

INT 5.3 **Rotational Dynamics and Energy**
+

CON 5.4 **Angular Momentum and Its Conservation**
+

Personal Progress Check 5

Multiple-choice: ~20 questions
Free-response: 1 question

UNIT
6

Oscillations

~5/~10 Class Periods | **6-14%** AP Exam Weighting

INT
+ **6.1 Simple Harmonic Motion, Springs, and Pendulums**

Personal Progress Check 6

Multiple-choice: ~10 questions
Free-response: 1 question

UNIT
7

Gravitation

~5/~10 Class Periods | **6-14%** AP Exam Weighting

FLD
+ **7.1 Gravitational Forces**

CON
+ **7.2 Orbits of Planets and Satellites**

Personal Progress Check 7

Multiple-choice: ~10 questions
Free-response: 1 question

AP PHYSICS C: MECHANICS

Unit Guides

Introduction

Designed with extensive input from the community of AP Physics C: Mechanics educators, the unit guides offer teachers helpful guidance in building students' skills and knowledge. The suggested sequence was identified through a thorough analysis of the syllabi of highly effective AP teachers and the organization of typical college textbooks.

This unit structure respects new AP teachers' time by providing one possible sequence they can adopt or modify rather than having to build from scratch. An additional benefit is that these units enable the AP Program to provide interested teachers with formative assessments—the Personal Progress Checks—that they can assign their students at the end of each unit to gauge progress toward success on the AP Exam. However, experienced AP teachers who are pleased with their current course organization and exam results should feel no pressure to adopt these units, which comprise an optional sequence for this course.

Using the Unit Guides

UNIT
1

14–20% AP EXAM WEIGHTING

~11–22 CLASS PERIODS

Kinematics

BIG IDEA 1
Changes That Can Be Measured

- When descending a hill on your bike, why do you roll faster the farther you go?
- Why should you throw a stone higher if you want it to go farther?

Developing Understanding

Although motion is considered an accepted phenomenon because it can easily be seen, discerning—and eventually understanding—why objects move requires more observation. Unit 1 introduces students to kinematics—particularly one-dimensional, two-dimensional, and projectile motion. Students will not only learn how to define each kinematic quantity (position, velocity, acceleration, and time), but also how to distinguish between them, and how to graphically and mathematically represent the relationships among them. Kinematics serves as a foundation for various physics principles and concepts, and in the units that follow, students are expected to call upon their knowledge of kinematic quantities to describe components of motion in a variety of scenarios, such as how acceleration is addressed with Newton's third law of motion.

Building the Science Practices

The ability to describe and explain physical processes, principles, and concepts is central to the study of physics. Physicists often create and use models and representations to analyze phenomena, make predictions, and communicate ideas. In this unit, students will practice demonstrating consistency between different types of representations of the same physical situation. For example, students will create a motion map, a velocity versus time graph, and a set of equations that all model the same motion of an object or a system. The content of Unit 1 provides students with multiple opportunities to discuss the relationships between variables and to model these relationships with various representations.

Unit 1 will also teach students to identify appropriate data to plot in order to describe patterns and trends in data, as patterns and trends help scientists understand relationships between fundamental laws and the world around them. Because identifying the appropriate data as well as identifying patterns gets easier with practice, introducing these skills in Unit 1 is important for student success.

Preparing for the AP Exam

Students should be able to identify, describe, and/or explain the relationships among features in graphs, free-body diagrams, and other representations. They should also be able to analyze patterns and trends in data (i.e., different motion plots) and use mathematical routines (selecting appropriate kinematic equations, deriving mathematical relationships, etc.).

Often, students studying kinematics have trouble recognizing one major difference between instantaneous and average velocity. That is, instantaneous velocity is a property of an object in motion at a single time, while the average velocity (total displacement divided by total time) of an object in motion depends on the total amount of time.

AP Physics C: Mechanics Course and Exam Description
Course Framework V.1 | 27

UNIT OPENERS

Developing Understanding provides an overview that contextualizes and situates the key content of the unit within the scope of the course.

Big ideas serve as the foundation of the course and develop understanding as they spiral throughout the course. The **essential questions** are thought-provoking questions that motivate students and inspire inquiry.

Building the Science Practices describes specific aspects of the practices that are appropriate to focus on in that unit.

Preparing for the AP Exam provides helpful tips and common student misunderstandings identified from prior exam data.

UNIT
1

Kinematics

UNIT AT A GLANCE

	Topic	Suggested Skills	Class Periods
CHM-1	<p>1.1 Kinematics: Motion in One Dimension</p>	<ul style="list-style-type: none"> 1.A Describe the physical meaning (includes identifying features) of a representation. 1.B Describe the relationship between different types of representations of the same physical situation. 1.C Select and plot appropriate data. 1.D Identify and describe patterns and trends in data or a graph. 1.E Linearize data and/or determine a best fit line or curve. 1.F Select an appropriate law, definition, or mathematical relationship, or model to describe a physical situation. 1.G Make a scientific claim. 	~11–22 CLASS PERIODS
CHM-2	<p>1.2 Kinematics: Motion in Two Dimensions</p>	<ul style="list-style-type: none"> 1.A Demonstrate consistency between different types of representations of the same physical situation. 1.B Determine the relationship between variables within an equation when an existing variable changes. 1.C Extract quantities from narratives or mathematical relationships to solve problems. 1.G Support a claim with evidence from experimental data. 	

Go to [AP Classroom](#) to assign the **Personal Progress Check** for Unit 1. Review the results in class to identify and address any student misunderstandings.

28 | Course Framework V.1
AP Physics C: Mechanics Course and Exam Description

The **Unit at a Glance** table shows the topics, related enduring understandings, and suggested skills. The “class periods” column has been left blank so teachers can customize the time they spend on each topic.

The **suggested skills** show how teachers can link the content in that topic to specific skills, which have been thoughtfully chosen in a way to allow teachers to scaffold those skills throughout the course. The questions on the Personal Progress Checks are based on this.

Using the Unit Guides

Kinematics

UNIT
1

SAMPLE INSTRUCTIONAL ACTIVITIES

The sample activities on this page are optional and are offered to provide possible ways to incorporate instructional approaches into the classroom. Teachers do not need to use these activities or instructional approaches and are free to alter or edit them. The examples below were developed in partnership with teachers from the AP community to share ways that they approach teaching some of the topics in this unit. Please refer to the Instructional Approaches section beginning on p. 115 for more examples of activities and strategies.

Activity	Topic	Sample Activity
1	1.1	Desktop Experiment Provide students with a pull-back toy car and a means to take video, and have them record position versus time data for the car as it speeds up and slows down. Have students fit a cubic polynomial to the position-time data and use calculus to predict the car's maximum speed and initial and final magnitude of acceleration.
2	1.2	Desktop Experiment Give students a ball launcher, right-triangular block, and meterstick. Have them calculate the launch speed of the ball using a horizontal launch of the ball from the launcher, then predict where the ball will land if the ball is launched on the triangular block.
3	1.1	Changing Representations Give students a verbal description of segmented motion, such as "accelerates from rest at 5 m/s ² for 10 seconds, then comes to rest again after another 20 seconds." Have students draw position/velocity/acceleration graphs and formulate piecewise position/velocity/acceleration equations of motion.
4	1.1	Create a Plan Find data of speed and total stopping distance for cars. Provide students with five pairs of speed and total stopping distances (not broken into thinking and braking distances). Ask students to determine from the data the driver's reaction time and the car's braking acceleration.
5	1.2	Graph and Switch Student A creates a horizontal and vertical pair of velocity graphs for projectile motion, and Student B must write a narrative of what happens (including whether the projectile was shot at an angle, lands higher or lower or at the same height).

Unit Planning Notes

Use the space below to plan your approach to the unit.

AP Physics C: Mechanics Course and Exam Description
Course Framework V.1 | 29

The **Sample Instructional Activities** page includes activities that help teachers tie together the content and skill of a particular topic.

UNIT
1
Kinematics

TOPIC 1.1 Kinematics: Motion in One Dimension

SUGGESTED SKILLS

- Visual Representations**
Describe the physical meaning (includes identifying features) of a representation.
- Describe the relationship between different types of representations of the same physical situation.
- Representing Data and Phenomena
Select and plot appropriate data.
- Analysis
Identify and describe patterns and trends in data or a graph.
- Linear Data and/or determine a best fit line or curve.
- Mathematical Routines
Select an appropriate law, definition, or mathematical relationship, or model to describe a physical situation.
- Argumentation
Make a scientific claim.

AVAILABLE RESOURCES

- AP Physics Featured Classroom Resources >
- AP Physics Featured Questions: Projectile Concepts
- AP Physics Featured Questions: Rotational Weights
- Critical Thinking Questions in Physics
- Physics Instruction Using Video Analysis Technology
- Quantitative Skills in the AP Sciences
- Teaching Strategies for Limited Class Time

Required Course Content

ENDURING UNDERSTANDING

CM-1.A
There are relationships among the vector quantities of position, velocity, and acceleration for the motion of a particle along a straight line.

LEARNING OBJECTIVE

CM-1.A.A
a. Determine the appropriate expressions for velocity and position as a function of time for an object accelerating uniformly in one dimension with given initial conditions.

b. Calculate unknown variables of motion such as acceleration, velocity, or positions for an object undergoing uniformly accelerated motion in one dimension.

c. Calculate values such as average velocity or maximum or minimum velocity for an object in uniform acceleration.

ESSENTIAL KNOWLEDGE

CM-1.A.A
The kinematic relationships for an object accelerating uniformly in one dimension are:

$$x = x_0 + v_0 t + \frac{1}{2} a t^2$$

$$v = v_0 + a t$$

$$v^2 = v_0^2 + 2a(x - x_0)$$

a. The constant velocity model can be derived from the above relationships.

$$v = \frac{\Delta x}{\Delta t}$$

b. The average velocity and acceleration models can also be derived from the above relationships.

$$v_{avg} = \frac{\Delta x}{\Delta t}$$

$$a_{avg} = \frac{\Delta v}{\Delta t}$$

continued on next page

TOPIC PAGES

The **suggested skills** offer possible skills to pair with the topic.

Enduring Understandings are the long-term takeaways related to the big ideas that leave a lasting impression on students. Students build and earn these understandings over time by exploring and applying course content throughout the year.

Learning objectives define what a student needs to be able to do with content knowledge in order to progress toward the enduring understandings.

Essential knowledge statements describe the knowledge required to perform the learning objective.

Where possible, **available resources** might help address a particular topic.

REQUIRED COURSE CONTENT LABELING SYSTEM

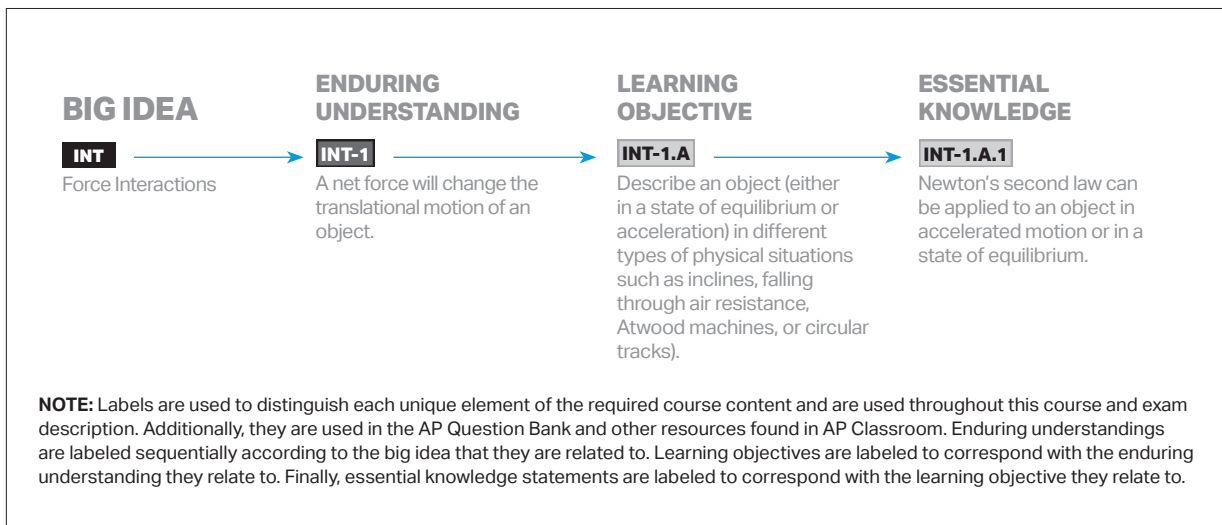

AP PHYSICS C: MECHANICS

UNIT 1

Kinematics



14–20%
AP EXAM WEIGHTING



~11/~22
CLASS PERIODS

The icon consists of a white circle containing a blue square with the letters 'AP' in white. Below the square are two horizontal lines, suggesting a computer screen or a digital interface.

Remember to go to [AP Classroom](#) to assign students the online **Personal Progress Check** for this unit.

Whether assigned as homework or completed in class, the **Personal Progress Check** provides each student with immediate feedback related to this unit's topic and skills.

Personal Progress Check 1

Multiple-Choice: ~15 questions

Free-Response: 1 question

Kinematics



Developing Understanding

BIG IDEA 1

Changes **CHA**

- When descending a hill on your bike, why do you roll faster the farther you go?
- Why should you throw a stone higher if you want it to go farther?

Although motion is considered an accepted phenomenon because it can easily be seen, discerning—and eventually understanding—*why* objects move requires more observation. Unit 1 introduces students to kinematics—particularly one-dimensional, two-dimensional, and projectile motion. Students will not only learn how to define each kinematic quantity (position, velocity, acceleration, and time), but also how to distinguish between them, and how to graphically and mathematically represent the relationships among them. Kinematics serves as a foundation for various physics principles and concepts, and in the units that follow, students are expected to call upon their knowledge of kinematic quantities to describe components of motion in a variety of scenarios, such as how acceleration is addressed with Newton’s third law of motion.

Building the Science Practices

1.C 3.A 4.A

The ability to describe and explain physical processes, principles, and concepts is central to the study of physics. Physicists often create and use models and representations to analyze phenomena, make predictions, and communicate ideas. In this unit, students will practice demonstrating consistency between different types of representations of the same physical situation. For example, students will create a motion map, a velocity versus time graph, and a set of equations that all model the same motion of an object or a system. The content of Unit 1 provides students with multiple opportunities to discuss the relationships between variables and to model these relationships with various representations.

Unit 1 will also teach students to identify appropriate data to plot in order to describe patterns and trends in data, as patterns and trends help scientists understand

relationships between fundamental laws and the world around them. Because identifying the appropriate data as well as identifying patterns gets easier with practice, introducing these skills in Unit 1 is important for student success.

Preparing for the AP Exam

Students should be able to identify, describe, and/or explain the relationships among features in graphs, free-body diagrams, and other representations. They should also be able to analyze patterns and trends in data (i.e., different motion plots) and use mathematical routines (selecting appropriate kinematic equations, deriving mathematical relationships, etc.).

Often, students studying kinematics have trouble recognizing one major difference between instantaneous and average velocity. That is, instantaneous velocity is a property of an object in motion at a single time, while the average velocity (total displacement divided by total time) of an object in motion depends on the total amount of time.

UNIT 1

Kinematics

UNIT AT A GLANCE

Enduring Understanding	Topic	Suggested Skills	Class Periods
			~11/~22 CLASS PERIODS
CHA-1	1.1 Kinematics: Motion in One Dimension	<p>1.A Describe the physical meaning (includes identifying features) of a representation.</p> <p>1.B Describe the relationship between different types of representations of the same physical situation.</p> <p>3.A Select and plot appropriate data.</p> <p>4.A Identify and describe patterns and trends in data or a graph.</p> <p>4.C Linearize data and/or determine a best fit line or curve.</p> <p>5.A Select an appropriate law, definition, or mathematical relationship, or model to describe a physical situation.</p> <p>7.A Make a scientific claim.</p>	
	1.2 Kinematics: Motion in Two Dimensions	<p>1.C Demonstrate consistency between different types of representations of the same physical situation.</p> <p>5.B Determine the relationship between variables within an equation when an existing variable changes.</p> <p>6.A Extract quantities from narratives or mathematical relationships to solve problems.</p> <p>7.B Support a claim with evidence from experimental data.</p>	
<p> Go to AP Classroom to assign the Personal Progress Check for Unit 1. Review the results in class to identify and address any student misunderstandings.</p>			

SAMPLE INSTRUCTIONAL ACTIVITIES

The sample activities on this page are optional and are offered to provide possible ways to incorporate instructional approaches into the classroom. Teachers do not need to use these activities or instructional approaches and are free to alter or edit them. The examples below were developed in partnership with teachers from the AP community to share ways that they approach teaching some of the topics in this unit. Please refer to the Instructional Approaches section beginning on p. 115 for more examples of activities and strategies.

Activity	Topic	Sample Activity
1	1.1	<p>Desktop Experiment</p> <p>Provide students with a pull-back toy car and a means to take video, and have them record position versus time data for the car as it speeds up and slows down. Have students fit a cubic polynomial to the position-time data and use calculus to predict the car's maximum speed and initial and final magnitude of acceleration.</p>
2	1.2	<p>Desktop Experiment</p> <p>Give students a ball launcher, right-triangular block, and meterstick. Have them calculate the launch speed of the ball using a horizontal launch of the ball from the launcher, then predict where the ball will land if the ball is launched on the triangular block.</p>
3	1.1	<p>Changing Representations</p> <p>Give students a verbal description of segmented motion, such as "accelerates from rest at 5 m/s^2 for 10 seconds, then comes to rest again after another 20 seconds." Have students draw position/velocity/acceleration graphs and formulate piecewise position/velocity/acceleration equations of motion.</p>
4	1.1	<p>Create a Plan</p> <p>Find data of speed and total stopping distance for cars. Provide students with five pairs of speed and total stopping distances (not broken into thinking and braking distances). Ask students to determine from the data the driver's reaction time and the car's braking acceleration.</p>
5	1.2	<p>Graph and Switch</p> <p>Student A creates a horizontal and vertical pair of velocity graphs for projectile motion, and Student B must write a narrative of what happens (including whether the projectile was shot at an angle, lands higher or lower or at the same height).</p>



Unit Planning Notes

Use the space below to plan your approach to the unit.

.....

.....

.....

SUGGESTED SKILLS

 *Visual Representations*

1.A Describe the physical meaning (includes identifying features) of a representation.

1.B Describe the relationship between different types of representations of the same physical situation.

 *Representing Data and Phenomena*

3.A Select and plot appropriate data.

 *Analysis*

4.A Identify and describe patterns and trends in data or a graph.

4.C Linearize data and/or determine a best fit line or curve.

 *Mathematical Routines*

5.A Select an appropriate law, definition, or mathematical relationship, or model to describe a physical situation.

 *Argumentation*

7.A Make a scientific claim.



AVAILABLE RESOURCES

Classroom Resources >

- [AP Physics Featured Question: Projectile Concepts](#)
- [AP Physics Featured Question: Raft with Hanging Weights](#)
- [Critical Thinking Questions in Physics](#)
- [Physics Instruction Using Video Analysis Technology](#)
- [Quantitative Skills in the AP Sciences](#)
- [Teaching Strategies for Limited Class Time](#)

TOPIC 1.1

Kinematics: Motion in One Dimension

Required Course Content

ENDURING UNDERSTANDING

CHA-1

There are relationships among the vector quantities of position, velocity, and acceleration for the motion of a particle along a straight line.

LEARNING OBJECTIVE

CHA-1.A

- a. Determine the appropriate expressions for velocity and position as a function of time for an object accelerating uniformly in one dimension with given initial conditions.
- b. Calculate unknown variables of motion such as acceleration, velocity, or positions for an object undergoing uniformly accelerated motion in one dimension.
- c. Calculate values such as average velocity or minimum or maximum velocity for an object in uniform acceleration.

ESSENTIAL KNOWLEDGE

CHA-1.A.1

The kinematic relationships for an object accelerating uniformly in one dimension are:

$$x = x_0 + v_{x_0}t + \frac{1}{2}a_x t^2$$

$$v_x = v_{x_0} + a_x t$$

$$v_x^2 = v_{x_0}^2 + 2a_x(x - x_0)$$

- a. The constant velocity model can be derived from the above relationships.

$$v_x = \frac{\Delta x}{\Delta t}$$

- b. The average velocity and acceleration models can also be derived from the above relationships.

$$v_{x(\text{avg})} = \frac{\Delta x}{\Delta t}$$

$$a_{x(\text{avg})} = \frac{\Delta v_x}{\Delta t}$$

continued on next page

LEARNING OBJECTIVE**CHA-1.B**

Determine functions of position, velocity, and acceleration that are consistent with each other, for the motion of an object with a nonuniform acceleration.

CHA-1.C

Describe the motion of an object in terms of the consistency that exists between position and time, velocity and time, and acceleration and time.

ESSENTIAL KNOWLEDGE**CHA-1.B.1**

Differentiation and integration are necessary for determining functions that relate position, velocity, and acceleration for an object with nonuniform acceleration.

$$v_x = \frac{dx}{dt}$$

$$a_x = \frac{dv_x}{dt}$$

- These functions may include trigonometric, power, or exponential functions of time.
- They may also include a velocity-dependent acceleration function (such as a resistive force).

CHA-1.C.1

Position, velocity, and acceleration versus time for a moving object are related to each other and depend on an understanding of slope, intercepts, asymptotes, and area or upon conceptual calculus concepts.

- These functions may include trigonometric, power, exponential functions (of time) or velocity-dependent functions.

SUGGESTED SKILLS

 *Visual Representations*

1.C Demonstrate consistency between different types of representations of the same physical situation.

 *Theoretical Relationships*

5.B Determine the relationship between variables within an equation when an existing variable changes.

 *Mathematical Routines*

6.A Extract quantities from narratives or mathematical relationships to solve problems.

 *Argumentation*

7.B Support a claim with evidence from experimental data.



AVAILABLE RESOURCES

Classroom Resources >

- [AP Physics Featured Question: Projectile Concepts](#)
- [AP Physics Featured Question: Raft with Hanging Weights](#)
- [Critical Thinking Questions in Physics](#)
- [Physics Instruction Using Video Analysis Technology](#)
- [Quantitative Skills in the AP Sciences](#)
- [Teaching Strategies for Limited Class Time](#)

TOPIC 1.2

Kinematics: Motion in Two Dimensions

Required Course Content

ENDURING UNDERSTANDING

CHA-2

There are multiple simultaneous relationships among the quantities of position, velocity, and acceleration for the motion of a particle moving in more than one dimension with or without net forces.

LEARNING OBJECTIVE

CHA-2.A

- a. Calculate the components of a velocity, position, or acceleration vector in two dimensions.
- b. Calculate a net displacement of an object moving in two dimensions.
- c. Calculate a net change in velocity of an object moving in two dimensions.
- d. Calculate an average acceleration vector for an object moving in two dimensions.
- e. Calculate a velocity vector for an object moving relative to another object (or frame of reference) that moves with a uniform velocity.
- f. Describe the velocity vector for one object relative to a second object with respect to its frame of reference.

ESSENTIAL KNOWLEDGE

CHA-2.A.1

All of the kinematic quantities are vector quantities and can be resolved into components (on a given coordinate system).

- a. Vector addition and subtraction are necessary to properly determine changes in quantities.
- b. The position, average velocity, and average acceleration can be represented in the following vector notation:

$$\vec{r} = \vec{x} + \vec{y} + \vec{z}$$

$$\vec{v}_{avg} = \frac{\Delta \vec{r}}{\Delta t}$$

$$\vec{a}_{avg} = \frac{\Delta \vec{v}}{\Delta t}$$

continued on next page

LEARNING OBJECTIVE**CHA-2.B**

Derive an expression for the vector position, velocity, or acceleration of a particle, at some point in its trajectory, using a vector expression or using two simultaneous equations.

ESSENTIAL KNOWLEDGE**CHA-2.B.1**

Differentiation and integration are necessary for determining functions that relate position, velocity, and acceleration for an object in each dimension.

$$v_x = \frac{dx}{dt}$$

$$a_x = \frac{dv_x}{dt}$$

- The accelerations may be different in each direction and may be nonuniform.
- The resultant vector of a given quantity such as position, velocity, or acceleration is the vector sum of the components of each quantity.

CHA-2.C

Calculate kinematic quantities of an object in projectile motion, such as displacement, velocity, speed, acceleration, and time, given initial conditions of various launch angles, including a horizontal launch at some point in its trajectory.

CHA-2.C.1

Motion in two dimensions can be analyzed using the kinematic equations if the motion is separated into vertical and horizontal components.

- Projectile motion assumes negligible air resistance and therefore constant horizontal velocity and constant vertical acceleration (earth's gravitational acceleration).
- These kinematic relationships only apply to constant (uniform) acceleration situations and can be applied in both x and y directions.

$$x = x_0 + v_{x_0}t + \frac{1}{2}a_x t^2$$

$$v_x = v_{x_0} + a_x t$$

$$v_x^2 = v_{x_0}^2 + 2a_x(x - x_0)$$

CHA-2.D

Describe the motion of an object in two-dimensional motion in terms of the consistency that exists between position and time, velocity and time, and acceleration and time.

CHA-2.D.1

The position, velocity, and acceleration versus time for a moving object are related to each other and depend on understanding of slope, intercepts, asymptotes, and area or upon conceptual calculus concepts.

THIS PAGE IS INTENTIONALLY LEFT BLANK.

AP PHYSICS C: MECHANICS

UNIT 2

Newton's Laws of Motion



17–23%
AP EXAM WEIGHTING



~12/~24
CLASS PERIODS

The icon consists of a white circle containing a blue square with the letters 'AP' in white. Below the square are two horizontal lines, suggesting a computer screen or a digital interface.

AP

Remember to go to [AP Classroom](#) to assign students the online **Personal Progress Check** for this unit.

Whether assigned as homework or completed in class, the **Personal Progress Check** provides each student with immediate feedback related to this unit's topic and skills.

Personal Progress Check 2

Multiple-Choice: ~25 questions

Free-Response: 1 question

Newton's Laws of Motion



Developing Understanding

BIG IDEA 2

Force Interactions **INT**

- Why does the swirling motion continue after you've stopped stirring a cup of coffee or tea?
- If you apply the same amount of "push" to a car as you would a shopping cart, why doesn't it move?
- Why will the sun set tomorrow in nearly the same place that it set today?
- Why must you push backward to make a skateboard move forward?

To understand how and why objects move, students must first understand the role forces play in motion. Unit 2 investigates Newton's laws of motion, which describe the relationship among moving objects and the forces acting on them. Students will learn how forces can change the motion of an object (first law); about the relationship between force, mass, and motion (second law); and why balanced forces become unbalanced (third law). These laws form the foundation of classical mechanics, and in subsequent units, students will evolve their understanding by applying Newton's laws of motion to a variety of physics principles, including the conservation of energy (Unit 3), rotation (Unit 5), simple harmonic motion (Unit 6), and the orbital motion of satellites (Unit 7).

Building the Science Practices

1.B **2.D** **7.C**

The ability to create, describe, and use representations is central to the study of physics. Physicists create and use models and representations to analyze phenomena, make predictions, and communicate ideas. In Unit 2, students will describe and discuss the relationships between different types of representations (for example, mathematical models and free-body diagrams) of the same physical situation and will re-express one type of representation as another.

The laboratory focus in Unit 2 encourages students to make observations and/or collect data from representations of laboratory setups or results. Students are required to determine an appropriate experimental procedure, including sketches of the laboratory setup to answer a scientific question.

Unit 2 also provides opportunities to develop the skill of crafting scientific arguments. Scientific arguments may specify a cause-and-effect relationship between variables or describe a mechanism through which a phenomenon occurs. By the end of the unit, students should be able to identify the

evidence necessary to defend a claim, be able to identify a fundamental principle of physics to begin the reasoning process, and begin to sketch out the support for a claim citing evidence from physical representations.

Preparing for the AP Exam

Students often struggle with knowing where to begin with laboratory design free-response questions. For help, we recommend they perform scaffolded activities and labs to determine the appropriate data needed to answer a scientific question. Teachers can refer to the learning objectives aligned to this unit to create these activities.

On the AP Exam, a free-response question may require students to create, use, and analyze graphs and representations (i.e., free-body force diagrams) when applying Newton's second law of motion. Students must select an appropriate law, definition, or model to describe a physical situation and/or develop a logical and coherent argument (or aspects of one). For example, when given a scenario in which two almost identical masses are hung on opposite sides of a pulley, students should be able to predict and justify why the acceleration of the system will be much smaller than the acceleration due to gravity.

UNIT 2

Newton's Laws of Motion

UNIT AT A GLANCE

Enduring Understanding	Topic	Suggested Skills	Class Periods
INT-1	2.1 Newton's Laws of Motion: First and Second Law	<p>1.A Describe the physical meaning (includes identifying features) of a representation.</p> <p>2.D Make observations or collect data from representations of laboratory setups or results.</p> <p>3.B Represent features of a model or the behavior of a physical system using appropriate graphing techniques, appropriate scale, and units.</p> <p>4.B Demonstrate consistency between different graphical representations of the same physical situation.</p> <p>5.A Select an appropriate law, definition, mathematical relationship, or model to describe a physical situation.</p> <p>7.A Make a scientific claim.</p> <p>7.B Support a claim with evidence from experimental data.</p>	~12/~24 CLASS PERIODS
INT-2	2.2 Circular Motion	<p>1.B Describe the relationship between different types of representations of the same physical situation.</p> <p>5.C Determine the relationship between variables within an equation when a new variable is introduced.</p> <p>6.B Apply an appropriate law, definition, or mathematical relationship to solve a problem.</p>	
INT-3	2.3 Newton's Laws of Motion: Third Law	<p>1.C Demonstrate consistency between different types of representations of the same physical situation.</p> <p>5.C Determine the relationship between variables within an equation when a new variable is introduced.</p> <p>5.D Determine or estimate the change in a quantity using a mathematical relationship.</p> <p>7.C Support a claim with evidence from physical representations.</p> <p>7.D Provide reasoning to justify a claim using physical principles or laws.</p>	
<p>Go to AP Classroom to assign the Personal Progress Check for Unit 2. Review the results in class to identify and address any student misunderstandings.</p>			

SAMPLE INSTRUCTIONAL ACTIVITIES

The sample activities on this page are optional and are offered to provide possible ways to incorporate instructional approaches into the classroom. Teachers do not need to use these activities or instructional approaches and are free to alter or edit them. The examples below were developed in partnership with teachers from the AP community to share ways that they approach teaching some of the topics in this unit. Please refer to the Instructional Approaches section beginning on p. 115 for more examples of activities and strategies.

Activity	Topic	Sample Activity
1	2.2	Desktop Experiment Drill a small hole in the center of a wooden meterstick so that a pencil point fits in the hole. Place a penny on the meterstick and gently rotate the meterstick faster and faster until the penny slips. Have students make measurements and calculations to find the coefficient of static friction between the meterstick and the penny.
2	2.1	Graph and Switch Student A produces a free-body diagram. Student B is to suggest a situation where the forces on an object would be described by that diagram.
3	2.3	Discussion Groups Have students explain why a strong man will win against a small child in tug-of-war, even though the rope always has the same tension at both ends. Have students support their reasoning with free-body diagrams.
4	2.1	Desktop Experiment Ask students to find the coefficient of friction (static or kinetic) of a shoe or other object. This activity can be made into a competition, where the team with the simplest procedure or the team that uses the least equipment wins.
5	2.1	Desktop Experiment Give students an object having unknown-mass (or have students use their set of house keys, if available), known masses, string, pulley, meterstick, and stopwatch. Have students determine the unknown mass of the object.



Unit Planning Notes

Use the space below to plan your approach to the unit.

.....

.....

.....

SUGGESTED SKILLS

 *Visual Representations*

1.A Describe the physical meaning (includes identifying features) of a representation.

 *Question and Method*

2.D Make observations or collect data from representations of laboratory setups or results.

 *Representing Data and Phenomena*

3.B Represent features of a model or the behavior of a physical system using appropriate graphing techniques, appropriate scale, and units.

 *Data Analysis*

4.B Demonstrate consistency between different graphical representations of the same physical situation.

 *Theoretical Relationships*

5.A Select an appropriate law, definition, mathematical relationship, or model to describe a physical situation.

 *Argumentation*

7.A Make a scientific claim.

7.B Support a claim with evidence from experimental data.



AVAILABLE RESOURCES

Classroom Resources >

- [AP Physics Featured Question: Projectile Concepts](#)
- [AP Physics Featured Question: Raft with Hanging Weights](#)
- [Critical Thinking Questions in Physics](#)
- [Physics Instruction Using Video Analysis Technology](#)

continued on next page

TOPIC 2.1

Newton's Laws of Motion: First and Second Law

Required Course Content

ENDURING UNDERSTANDING

INT-1

A net force will change the translational motion of an object.

LEARNING OBJECTIVE

INT-1.A

Describe an object (either in a state of equilibrium or acceleration) in different types of physical situations such as inclines, falling through air resistance, Atwood machines, or circular tracks).

INT-1.B

- a. Explain Newton's first law in qualitative terms and apply the law to many different physical situations.
- b. Calculate a force of unknown magnitude acting on an object in equilibrium.

ESSENTIAL KNOWLEDGE

INT-1.A.1

Newton's second law can be applied to an object in accelerated motion or in a state of equilibrium.

INT-1.B.1

Newton's first law is the special case of the second law. When the acceleration of an object is zero (i.e., velocity is constant or equal to zero), the object is in a state of equilibrium and the following statements are true:

$$\sum F_x = 0$$

$$\sum F_y = 0$$

- a. Forces can be resolved into components and these components can be separately added in their respective directions.

continued on next page

LEARNING OBJECTIVE

INT-1.C

- Calculate the acceleration of an object moving in one dimension when a single constant force (or a net constant force) acts on the object during a known interval of time.
- Calculate the average force acting on an object moving in a plane with a velocity vector that is changing over a specified time interval.
- Describe the trajectory of a moving object that experiences a constant force in a direction perpendicular to its initial velocity vector.
- Derive an expression for the net force on an object in translational motion.
- Derive a complete Newton's second law statement (in the appropriate direction) for an object in various physical dynamic situations (e.g., mass on incline, mass in elevator, strings/pulleys, or Atwood machines).

INT-1.D

Calculate a value for an unknown force acting on an object accelerating in a dynamic situation (e.g., inclines, Atwood machines, falling with air resistance, pulley systems, mass in elevator, etc.).

ESSENTIAL KNOWLEDGE

INT-1.C.1

The appropriate use of Newton's second law is one of the fundamental skills in mechanics.

$$\vec{a} = \frac{\sum \vec{F}}{m}$$

- The second law is a vector relationship. It may be necessary to draw complete free-body diagrams to determine unknown forces acting on an object.
- Forces acting parallel to the velocity vector have the capacity to change the speed of the object.
- Forces acting in the perpendicular direction have the capacity to change the direction of the velocity vector.

INT-1.D.1

Using appropriate relationships derived from a Newton's second law analysis, unknown forces (or accelerations) can be determined from the given known physical characteristics.



AVAILABLE RESOURCES

Classroom Resources >

- [Quantitative Skills in the AP Sciences](#)
- [Teaching Strategies for Limited Class Time](#)

continued on next page

LEARNING OBJECTIVE

INT-1.E

- Describe the relationship between frictional force and the normal force for static friction and for kinetic friction.
- Explain when to use the static frictional relationship versus the kinetic frictional relationship in different physical situations (e.g., object sliding on surface or object not slipping on incline).

INT-1.F

Describe the direction of frictional forces (static or kinetic) acting on an object under various physical situations.

INT-1.G

- Derive expressions that relate mass, forces, or angles of inclines for various slipping conditions with friction.
- Calculate the value for the static frictional force for an object in various dynamic situations (e.g., an object at rest on truck bed, an object at rest on incline, or an object pinned to a horizontal surface).

ESSENTIAL KNOWLEDGE

INT-1.E.1

The relationship for the frictional force acting on an object on a rough surface is:

$$|\vec{F}_{fs}| \leq \mu_s |\vec{F}_N|$$

$$|\vec{F}_{fk}| = \mu_k |\vec{F}_N|$$

INT-1.F.1

The direction of friction can be determined by the relative motion between surfaces in kinetic frictional cases.

- In cases where the direction of friction is not obvious or is not directly evident from relative motion, then the net motion of the object and the other forces acting on the object are required to determine the direction of the frictional force.

INT-1.G.1

The maximum value of static friction has a precise relationship:

$$|\vec{F}_{fs}| = \mu_s |\vec{F}_N|$$

- This relationship can be used to determine values such as, "The maximum angle of incline at which the block will not slip."

continued on next page

LEARNING OBJECTIVE

INT-1.H

- Derive an expression for the motion of an object freely falling with a resistive drag force (or moving horizontally subject to a resistive horizontal force).
- Describe the acceleration, velocity, or position in relation to time for an object subject to a resistive force (with different initial conditions, i.e., falling from rest or projected vertically).

INT-1.I

Calculate the terminal velocity of an object moving vertically under the influence of a resistive force of a given relationship.

INT-1.J

- Derive a differential equation for an object in motion subject to a specified resistive force.
- Derive an expression for a time-dependent velocity function for an object moving under the influence of a given resistive force (with given initial conditions).
- Derive expressions for the acceleration or position of an object moving under the influence of a given resistive force.

ESSENTIAL KNOWLEDGE

INT-1.H.1

The standard “resistive force” in this course is defined as a velocity-dependent force in the opposite direction of velocity, for example:

$$\vec{F}_r = -k\vec{v}$$

or

$$|\vec{F}_r| = kv^2$$

INT-1.I.1

The terminal velocity is defined as the maximum speed achieved by an object falling under the influence of a given drag force. The terminal condition is reached when the magnitude of the drag force is equal to the magnitude of the weight of the object.

INT-1.J.1

Because the resistive force is a function of velocity, applying Newton’s second law correctly will lead to a differential equation for velocity. This is an example of that statement:

$$\frac{dv}{dt} = -\frac{k}{m}v$$

- Using the method of separation of variables, the velocity can be determined from relationships by correctly integrating over the proper limits of integration.
- The acceleration or position can be determined using methods of calculus once a function for velocity is determined.

SUGGESTED SKILLS

 *Visual Representations*

1.B Describe the relationship between different types of representations of the same physical situation.

 *Theoretical Relationships*

5.C Determine the relationship between variables within an equation when a new variable is introduced.

 *Mathematical Routines*

6.B Apply an appropriate law, definition, or mathematical relationship to solve a problem.



AVAILABLE RESOURCES

Classroom Resources >

- [AP Physics Featured Question: Projectile Concepts](#)
- [AP Physics Featured Question: Raft with Hanging Weights](#)
- [Critical Thinking Questions in Physics](#)
- [Physics Instruction Using Video Analysis Technology](#)
- [Quantitative Skills in the AP Sciences](#)
- [Teaching Strategies for Limited Class Time](#)

TOPIC 2.2

Circular Motion

Required Course Content

ENDURING UNDERSTANDING

INT-2

The motion of some objects is constrained so that forces acting on the object cause it to move in a circular path.

LEARNING OBJECTIVE

INT-2.A

- a. Calculate the velocity of an object moving in a horizontal circle with a constant speed, when subject to a known centripetal force.
- b. Calculate relationships among the radius of a circle, the speed of an object (or period of revolution), and the magnitude of centripetal acceleration for an object moving in uniform circular motion.

ESSENTIAL KNOWLEDGE

INT-2.A.1

Centripetal acceleration is defined by:

$$a_c = \frac{v^2}{r}$$

or defined using angular velocity:

$$a_c = \omega^2 r$$

- a. Uniform circular motion is defined as an object moving in a circle with a constant speed.
- b. The net force acting in the radial direction can be determined by applying Newton's second law in the radial direction.

continued on next page

LEARNING OBJECTIVE

INT-2.B

- Explain how a net force in the centripetal direction can be a single force, more than one force, or even components of forces that are acting on an object moving in circular motion.
- Describe forces that are exerted on objects undergoing horizontal circular motion, vertical circular motion, or horizontal circular motion on a banked curve.
- Describe forces that are acting on different objects traveling in different circular paths.

INT-2.C

- Describe the direction of the velocity and acceleration vector for an object moving in two dimensions, circular motion, or uniform circular motion.
- Calculate the resultant acceleration for an object that changes its speed as it moves in a circular path.

INT-2.D

Derive expressions relating centripetal force to the minimum speed or maximum speed of an object moving in a vertical circular path.

INT-2.E

Derive expressions relating the centripetal force to the maximum speed of an object or minimum speed of an object moving in a circular path on a banked surface with friction.

ESSENTIAL KNOWLEDGE

INT-2.B.1

In order for an object to undergo circular motion in any context, there must be a force, multiple forces, or components of forces acting in the radial direction. These forces can be represented with appropriate free-body diagrams.

INT-2.C.1

An object that changes directions will always have an acceleration component that is perpendicular to the velocity vector. The velocity vector will always be tangential to the path of the particle.

- As an object moves in a circle with changing speed, the resultant acceleration, at any point, is the vector sum of the radial acceleration and tangential acceleration.

INT-2.D.1

The centripetal force is provided only by the gravitational force for an object moving at minimum speed at the top of a vertical circle. This speed is called "critical speed" in certain textbooks.

- The maximum speed occurs at the bottom of the circle and is related to all of the vertical forces acting on the object.

INT-2.E.1

Components of the static friction force and the normal force can contribute to the centripetal force for an object traveling in a circle on a banked surface.

SUGGESTED SKILLS

 *Visual Representations*

1.C Demonstrate consistency between different types of representations of the same physical situation.

 *Theoretical Relationships*

5.C Determine the relationship between variables within an equation when a new variable is introduced.

5.D Determine or estimate the change in a quantity using a mathematical relationship.

 *Argumentation*

7.C Support a claim with evidence from physical representations.

7.D Provide reasoning to justify a claim using physical principles or laws.



AVAILABLE RESOURCES

Classroom Resources >

- [AP Physics Featured Question: Projectile Concepts](#)
- [AP Physics Featured Question: Raft with Hanging Weights](#)
- [Critical Thinking Questions in Physics](#)
- [Physics Instruction Using Video Analysis Technology](#)
- [Quantitative Skills in the AP Sciences](#)
- [Teaching Strategies for Limited Class Time](#)

TOPIC 2.3

Newton's Laws of Motion: Third Law

Required Course Content

ENDURING UNDERSTANDING

INT-3

There are force pairs with equal magnitude and opposite directions between any two interacting objects.

LEARNING OBJECTIVE

INT-3.A

- a. Describe the forces of interaction between two objects (Newton's third law).
- b. Describe pairs of forces that occur in a physical system due to Newton's third law.
- c. Describe the forces that occur between two (or more) objects accelerating together (e.g., in contact or connected by light strings, springs, or cords).

INT-3.B

Derive expressions that relate the acceleration of multiple connected masses moving in a system (e.g., Atwood machines) connected by light strings with tensions (and pulleys).

ESSENTIAL KNOWLEDGE

INT-3.A.1

The forces exerted between objects are equal in magnitude and opposite in direction.

- a. Third law force pairs are always internal to the system of the two objects that are interacting.
- b. Each force in the pair is always the same type of force.

INT-3.B.1

To analyze a complete system of multiple connected masses in motion, several applications of Newton's second law in conjunction with Newton's third law may be necessary. This may involve solving two or three simultaneous linear equations.

AP PHYSICS C: MECHANICS

UNIT 3

Work, Energy, and Power



14–17%
AP EXAM WEIGHTING



~10/~20
CLASS PERIODS

The icon consists of a white circle containing a blue square with the letters 'AP' in white. Below the square are two horizontal lines, suggesting a computer screen or a digital interface.

AP

Remember to go to [AP Classroom](#) to assign students the online **Personal Progress Check** for this unit.

Whether assigned as homework or completed in class, the **Personal Progress Check** provides each student with immediate feedback related to this unit's topic and skills.

Personal Progress Check 3

Multiple-Choice: ~20 questions

Free-Response: 1 question

Work, Energy, and Power



Developing Understanding

BIG IDEA 2

Force Interactions **INT**

- Why is no work done when you push against a wall, but work is done when you coast down a hill?

BIG IDEA 4

Conservation **CON**

- Why does a stretched rubber band return to its original length?
- Why is it easier to walk up a flight of steps, rather than run, when the gravitational potential energy of the system is the same?

Are you working hard, or hardly working? The answer depends on how you define *work*. In Unit 3, students will explore the relationship between work, energy, and power and will be introduced to the principle of conservation as a foundational model of physics, as well as the concept of work as an agent of change for energy. Students are not only expected to functionally define and calculate work, energy, and power, but must also be comfortable graphically and mathematically representing them. Understanding these relationships will help students make connections to other content presented in the course. For instance, students can use the concept of work to link the principles of energy transfer, forces, momentum, and certain kinematic equations.

Building the Science Practices

2.E 5.C 6.C

Scientific questions can range in scope as well as specificity. Students will identify or describe the appropriate principle needed to answer a specific scientific question, as well as the potential sources of experimental uncertainty. Students will identify and/or describe potential sources of experimental error either in their own experiments or when given an experimental setup.

Students will develop the practice of argumentation by predicting the causes or effects of a change in, or disruption to, one or more components in a system. It is essential that students are able to clearly demonstrate the ability to determine the relationship between variables within an equation when a new variable is introduced. Students also need scaffolded practice with clearly calculating unknown quantities from known quantities from selecting and

following logical computational pathways. Students who are unable to be clear in their calculations and derivations will lose points on questions that ask them to calculate—or in other words, to clearly show their computational steps.

Preparing for the AP Exam

When answering free-response questions, students should be able to select relevant features of a graph to describe a physical situation (e.g., graphs of force versus position, where the area under the curve is equal to the work done). Students should also be able to derive symbolic expressions from known quantities, as well as apply the appropriate laws, definitions, and/or mathematical relationships to perform a calculation or solve a problem. For example, students could be asked to apply the work-energy theorem to a scenario or calculate the negative integral of force with respect to position to determine the change in potential energy of a system.

UNIT AT A GLANCE

Enduring Understanding	Topic	Suggested Skills	Class Periods
INT-4	3.1 Work-Energy Theorem	<p>2.A Identify a testable scientific question or problem.</p> <p>7.C Support a claim with evidence from physical representations.</p>	~10/~20 CLASS PERIODS
CON-1	3.2 Forces and Potential Energy	<p>1.D Select relevant features of a representation to answer a question or solve a problem.</p> <p>4.B Demonstrate consistency between different graphical representations of the same physical situation.</p> <p>6.A Extract quantities from narratives or mathematical relationships to solve problems.</p>	
CON-2	3.3 Conservation of Energy	<p>2.E Identify or describe potential sources of experimental error.</p> <p>4.D Select relevant features of a graph to describe a physical situation or solve problems.</p> <p>5.C Determine the relationship between variables within an equation when a new variable is introduced.</p> <p>6.C Calculate an unknown quantity with units from known quantities by selecting and following a logical computational pathway.</p> <p>7.E Explain the connection between experimental results and larger physical principles, laws, or theories.</p>	
CON-3	3.4 Power	<p>5.D Determine or estimate the change in a quantity using a mathematical relationship.</p>	
<p> Go to AP Classroom to assign the Personal Progress Check for Unit 3. Review the results in class to identify and address any student misunderstandings.</p>			

SAMPLE INSTRUCTIONAL ACTIVITIES

The sample activities on this page are optional and are offered to provide possible ways to incorporate instructional approaches into the classroom. Teachers do not need to use these activities or instructional approaches and are free to alter or edit them. The examples below were developed in partnership with teachers from the AP community to share ways that they approach teaching some of the topics in this unit. Please refer to the Instructional Approaches section beginning on p. 115 for more examples of activities and strategies.

Activity	Topic	Sample Activity
1	3.3	<p>Bar Chart</p> <p>Present students with a sequence of two or three energy bar charts and have them describe a realistic situation that would involve those energy transformations. Students must also draw a diagram of the situation.</p>
2	3.2	<p>Graph and Switch</p> <p>Student A constructs a potential energy (PE) function that has at least one minimum and a graph of that function. Student B formulates AP-level questions about the PE function (i.e., "If a 2 kg mass is released at $x = 3$ m, what is its speed at $x = 9$ m?") that Student C must answer.</p>
3	3.3	<p>Desktop Experiment</p> <p>Using spring-loaded suction cup launchers, have students measure the spring constant of the spring, not by removing the spring from the launcher, but by measuring some aspect of the suction cup's motion after being launched.</p>
4	3.4	<p>Identify Subtasks</p> <p>Have students construct graph of power delivered to a car as a function of time as the car accelerates from rest and reaches full speed. Next, ask students to determine the car's mass and its velocity as a function of time.</p>
5	3.3	<p>Changing Representations</p> <p>Have each student describe an everyday activity that involves the transfer of mechanical energy. Students then construct energy bar charts showing the exchanges of energy and free-body diagrams to show the forces doing work, and flowcharts to show the flow of energy from one system or form to another.</p>



Unit Planning Notes

Use the space below to plan your approach to the unit.

.....

.....

.....

SUGGESTED SKILLS

 Question and Method

2.A Identify a testable scientific question or problem.

 Argumentation

7.C Support a claim with evidence from physical representations.



AVAILABLE RESOURCES

Classroom Resources >

- [AP Physics Featured Question: Projectile Concepts](#)
- [AP Physics Featured Question: Raft with Hanging Weights](#)
- [Critical Thinking Questions in Physics](#)
- [Physics Instruction Using Video Analysis Technology](#)
- [Quantitative Skills in the AP Sciences](#)
- [Teaching Strategies for Limited Class Time](#)

TOPIC 3.1

Work-Energy Theorem

Required Course Content

ENDURING UNDERSTANDING

INT-4

When a force is exerted on an object, and the energy of the object changes, then work was done on the object.

LEARNING OBJECTIVE

INT-4.A

- a. Calculate work done by a given force (constant or as a given function $F(x)$) on an object that undergoes a specified displacement.
- b. Describe the work done on an object as the result of the scalar product between force and displacement.
- c. Explain how the work done on an object by an applied force acting on an object can be negative or zero.

INT-4.B

Calculate a value for work done on an object from a force versus position graph.

ESSENTIAL KNOWLEDGE

INT-4.A.1

The component of the displacement that is parallel to the applied force is used to calculate the work.

- a. The work done on an object by a force can be calculated using:

$$W = \int_a^b \vec{F}(r) \cdot d\vec{r}$$

- b. Work is a scalar value that can be positive, negative, or zero.
- c. The definition of work can be applied to an object when that object can be modeled as a point-like object.

INT-4.B.1

The area under the curve of a force versus position graph is equivalent to the work done on the object or system.

continued on next page

LEARNING OBJECTIVE

INT-4.C

- Calculate the change in kinetic energy due to the work done on an object or a system by a single force or multiple forces.
- Calculate the net work done on an object that undergoes a specified change in speed or change in kinetic energy.
- Calculate changes in an object's kinetic energy or changes in speed that result from the application of specified forces.

ESSENTIAL KNOWLEDGE

INT-4.C.1

The net work done on an (point-like) object is equal to the object's change in the kinetic energy.

$$W_{net} = \Delta K$$

- This is defined as the work-energy theorem. The work-energy theorem can be used when an object or system can be modeled as a point-like particle (i.e., nondeformable and not having the capacity for internal energy).
- The definition of kinetic energy is:

$$K = \frac{1}{2}mv^2$$

- Net work done on an object is equivalent to the sum of the individual work done on an object by each of the forces acting on the object (including conservative forces).

SUGGESTED SKILLS

 *Visual Representations*

1.D Select relevant features of a representation to answer a question or solve a problem.

 *Data Analysis*

4.B Demonstrate consistency between different graphical representations of the same physical situation.

 *Mathematical Routines*

6.A Extract quantities from narratives or mathematical relationships to solve problems.



AVAILABLE RESOURCES

Classroom Resources >

- [AP Physics Featured Question: Projectile Concepts](#)
- [AP Physics Featured Question: Raft with Hanging Weights](#)
- [Critical Thinking Questions in Physics](#)
- [Physics Instruction Using Video Analysis Technology](#)
- [Quantitative Skills in the AP Sciences](#)
- [Teaching Strategies for Limited Class Time](#)

TOPIC 3.2

Force and Potential Energy

Required Course Content

ENDURING UNDERSTANDING

CON-1

Conservative forces internal to the system can change the potential energy of that system.

LEARNING OBJECTIVE

CON-1.A

- a. Compare conservative and dissipative forces.
- b. Describe the role of a conservative force or a dissipative force in a dynamic system.

ESSENTIAL KNOWLEDGE

CON-1.A.1

- A force can be defined as a conservative force if the work done on an object by the force depends only on the initial and final position of the object.
- a. The work done by a conservative force will be zero if the object undergoes a displacement that completes a complete closed path.
 - b. Common dissipative forces discussed in this course are friction, resistive forces, or externally applied forces from some object external to the system.

continued on next page

LEARNING OBJECTIVE

CON-1.B

- Explain how the general relationship between potential energy functions and conservative forces is used to determine relationships between the two physical quantities.
- Derive an expression that represents the relationship between a conservative force acting in a system on an object to the potential energy of the system using the methods of calculus.

CON-1.C

Describe the force within a system and the potential energy of a system.

CON-1.D

- Derive the expression for the potential energy function of an ideal spring.
- Derive an expression for the potential energy function of a nonideal spring that has a nonlinear relationship with position.

ESSENTIAL KNOWLEDGE

CON-1.B.1

A definition that relates conservative forces internal to the system to the potential energy function of the system is:

$$\Delta U = -\int_a^b \vec{F}_{cf} \cdot d\vec{r}$$

- The differential version (in one dimension) of this relationship is:

$$F_x = -\frac{dU(x)}{dx}$$

CON-1.C.1

The general relationship between a conservative force and a potential energy function can be described qualitatively and graphically. For example, basic curve sketching principles can be applied to generate a sketch (e.g., slopes, area under the curve, intercepts, etc.).

CON-1.D.1

An ideal spring acting on an object is an example of a conservative force within a system (spring-object system). The ideal spring relationship is modeled by the following law and is also called "linear spring:"

$$\vec{F}_s = -k\Delta\vec{x}$$

- Using the general relationship between conservative force and potential energy, the potential energy for an ideal spring can be shown as:

$$U_s = \frac{1}{2}k(\Delta x)^2$$

- Nonlinear spring relationships can also be explored. These nonlinear forces are conservative since they are internal to the system (of spring-object) and dependent on position.

continued on next page

LEARNING OBJECTIVE

CON-1.E

Calculate the potential energy of a system consisting of an object in a uniform gravitational field.

CON-1.F

Derive an expression for the gravitational potential energy of a system consisting of a satellite or large mass (e.g., an asteroid) and the Earth at a great distance from the Earth.

ESSENTIAL KNOWLEDGE

CON-1.E.1

The definition of the gravitational potential energy of a system consisting of the Earth and an object of mass m near the surface of the Earth is:

$$\Delta U_g = mg\Delta h$$

CON-1.F.1

Using the relationship between the conservative force and potential energy, it can be shown that the gravitational potential energy of the object-Earth system is:

$$U_G = -\frac{Gm_1m_2}{r}$$

- The potential energy of the Earth-mass system is defined to be zero at an infinite distance from the Earth.

TOPIC 3.3

Conservation of Energy

Required Course Content

ENDURING UNDERSTANDING

CON-2

The energy of a system can transform from one form to another without changing the total amount of energy in the system.

LEARNING OBJECTIVE

CON-2.A

- Describe physical situations in which mechanical energy of an object in a system is converted to other forms of energy in the system.
- Describe physical situations in which the total mechanical energy of an object in a system changes or remains constant.

CON-2.B

Describe kinetic energy, potential energy, and total energy in relation to time (or position) for a “conservative” mechanical system.

ESSENTIAL KNOWLEDGE

CON-2.A.1

If only forces internal to the system are acting on an object in a physical system, then the total change in mechanical energy is zero.

- Total mechanical energy is defined as the sum of potential and kinetic energy:

$$E = U_g + K + U_s$$

- When nonconservative forces are acting on the system, the work they do changes the total energy of the system as follows:

$$W_{nc} = \Delta E$$

CON-2.B.1

In systems in which no external work is done, the total energy in that system is a constant. This is sometimes called a “conservative system.”

- Some common systems that are frequently analyzed in this way are systems such as pendulum systems, ball/rollercoaster track, frictionless ramps or tracks, or the mass/spring oscillator.

SUGGESTED SKILLS

 **Question and Method**

2.E Identify or describe potential sources of experimental error.

 **Data Analysis**

4.D Select relevant features of a graph to describe a physical situation or solve problems.

 **Theoretical Relationships**

5.C Determine the relationship between variables within an equation when a new variable is introduced.

 **Mathematical Routines**

6.C Calculate an unknown quantity with units from known quantities by selecting and following a logical computational pathway.

 **Argumentation**

7.E Explain the connection between experimental results and larger physical principles, laws, or theories.



AVAILABLE RESOURCES

Classroom Resources >

- AP Physics Featured Question: Projectile Concepts
- AP Physics Featured Question: Raft with Hanging Weights
- Critical Thinking Questions in Physics
- Physics Instruction Using Video Analysis Technology
- Quantitative Skills in the AP Sciences
- Teaching Strategies for Limited Class Time

continued on next page

LEARNING OBJECTIVE**CON-2.C**

- Calculate unknown quantities (e.g., speed or positions of an object) that are in a conservative system of connected objects, such as the masses in an Atwood machine, masses connected with pulley/string combinations, or the masses in a modified Atwood machine.
- Calculate unknown quantities, such as speed or positions of an object that is under the influence of an ideal spring.
- Calculate unknown quantities, such as speed or positions of an object that is moving under the influence of some other nonconstant one-dimensional force.

CON-2.D

Derive expressions such as positions, heights, angles, and speeds for an object in vertical circular motion or pendulum motion in an arc.

ESSENTIAL KNOWLEDGE**CON-2.C.1**

The application of the conservation of total mechanical energy can be used in many physical situations.

CON-2.D.1

In some cases, both Newton's second law and conservation of energy must be applied simultaneously to determine unknown physical characteristics in a system. One such example frequently explored is an object in a vertical circular motion in the Earth's gravity. A full treatment of force analysis and energy analysis would be required to determine some of the unknown features of the motion, such as the speed of the object at certain locations in the circular path.

TOPIC 3.4

Power

SUGGESTED SKILLS

 *Theoretical Relationships*

5.D Determine or estimate the change in a quantity using a mathematical relationship.



AVAILABLE RESOURCES

Classroom Resources >

- [AP Physics Featured Question: Projectile Concepts](#)
- [AP Physics Featured Question: Raft with Hanging Weights](#)
- [Critical Thinking Questions in Physics](#)
- [Physics Instruction Using Video Analysis Technology](#)
- [Quantitative Skills in the AP Sciences](#)
- [Teaching Strategies for Limited Class Time](#)

Required Course Content

ENDURING UNDERSTANDING

CON-3

The energy of an object or a system can be changed at different rates.

LEARNING OBJECTIVE

CON-3.A

- a. Derive an expression for the rate at which a force does work on an object.
- b. Calculate the amount of power required for an object to maintain a constant acceleration.
- c. Calculate the amount of power required for an object to be raised vertically at a constant rate.

ESSENTIAL KNOWLEDGE

CON-3.A.1

Power is defined by the following expressions:

- a. $P = \frac{dE}{dt}$
- b. $P = \vec{F} \cdot \vec{v}$

THIS PAGE IS INTENTIONALLY LEFT BLANK.

AP PHYSICS C: MECHANICS

UNIT 4

Systems of Particles and Linear Momentum



14–17%
AP EXAM WEIGHTING



~10/~20
CLASS PERIODS

The icon consists of a white circle containing a blue square with the letters 'AP' in white. Below the square are two horizontal lines, suggesting a computer screen or a digital interface.

Remember to go to [AP Classroom](#) to assign students the online **Personal Progress Check** for this unit.

Whether assigned as homework or completed in class, the **Personal Progress Check** provides each student with immediate feedback related to this unit's topic and skills.

Personal Progress Check 4

Multiple-Choice: ~15 questions

Free-Response: 1 question

Systems of Particles and Linear Momentum



Developing Understanding

BIG IDEA 1

Changes **CHA**

- Why do pictures hung on a wall sometimes tilt forward?
- Why will you fall if you lean too far over a bannister or ledge?

BIG IDEA 2

Force Interactions **INT**

- Why does water move a ship forward when its propellers push water backward?

BIG IDEA 4

Conservation **CON**

- Why are cannon barrels so much longer and heavier than cannonballs?

Have you ever wondered how a tennis player times a return shot? Alongside skill, players must consider a number of factors to estimate how far, fast, or high their swings should be. Unit 4 introduces students to these factors through the concepts of center of mass, impulse and momentum, and the conservation of linear momentum. Students will learn the relationship between impulse and momentum via application or calculations. The conservation of linear momentum and how it's applied to collisions is also addressed. Unit 4 offers a complete picture of the motion of a system, which is explored primarily through impulse and changes in momentum. Students will further their understanding of momentum and angular momentum in Unit 7 as they begin to articulate orbital and rotational motion.

Building the Science Practices

1.E 2.C 7.D

The analysis, interpretation, and application of quantitative information are vital skills for students in AP Physics. Opportunities for scientific inquiry should be designed and implemented with increasing student involvement to help enhance the development of inquiry learning, critical thinking, and problem-solving skills. The laboratory focus in Unit 4 encourages students to identify appropriate experimental procedures to answer scientific questions. Students are required to clearly and concisely determine an appropriate experimental procedure, including sketches of the laboratory setup.

Unit 4 continues to challenge students to work with representations to help describe what happens when the conditions of a scenario are changed. It is important students have scaffolded practice with modifying assumptions or conditions and making predictions about the results. It is also essential that

students can use fundamental principles of physics as evidence to defend and justify their claims.

Preparing for the AP Exam

To earn full credit on a free response question, students must demonstrate competency of the learning objectives. This can be achieved by having ample practice and opportunities to apply the science practices. For instance, students should be able to articulate assumptions and limits of a representation of a physical situation, including assuming symmetry of objects and systems and describing the limitations of conservation of kinetic energy in certain collisions. They should also be able to derive a symbolic expression from known quantities. For example, students should be able to derive a symbolic expression for the final velocity of two boxes after a collision.

Students should also be given multiple opportunities to develop a coherent and logical argument (or aspects of one) and to use physical principles and/or empirical data to justify a claim or prediction. An example of this practice includes verifying the law of conservation of momentum during an explosion.

**UNIT
4**

Systems of Particles and Linear Momentum

UNIT AT A GLANCE

Enduring Understandings	Topic	Suggested Skills	Class Periods
CHA-3	4.1 Center of Mass	6.B Apply an appropriate law, definition, or mathematical relationship to solve a problem.	~10/~20 CLASS PERIODS
INT-5	4.2 Impulse and Momentum	<p>1.C Demonstrate consistency between different types of representations of the same physical situation.</p> <p>2.C Identify appropriate experimental procedures to test a claim or prediction (which may include a sketch of a lab setup).</p> <p>5.D Determine or estimate the change in a quantity using a mathematical relationship.</p>	
CON-4	4.3 Conservation of Linear Momentum, Collisions	<p>1.E Describe the effects of modifying conditions or features of a representation of a physical situation.</p> <p>5.E Derive a symbolic expression from known quantities by selecting and following a logical algebraic pathway.</p> <p>7.D Provide reasoning to justify a claim using physical principles or laws.</p> <p>7.E Explain the connection between experimental results and larger physical principles, laws, or theories.</p> <p>7.F Explain how potential sources of experimental error may affect results and/or conclusions.</p>	
<p> Go to AP Classroom to assign the Personal Progress Check for Unit 4. Review the results in class to identify and address any student misunderstandings.</p>			

SAMPLE INSTRUCTIONAL ACTIVITIES

The sample activities on this page are optional and are offered to provide possible ways to incorporate instructional approaches into the classroom. Teachers do not need to use these activities or instructional approaches and are free to alter or edit them. The examples below were developed in partnership with teachers from the AP community to share ways that they approach teaching some of the topics in this unit. Please refer to the Instructional Approaches section beginning on p. 115 for more examples of activities and strategies.

Activity	Topic	Sample Activity
1	4.2	<p>Four-Square Problem Solving</p> <p>Present students with some problem where an object’s motion changes (such as a car on an on-ramp entering a freeway). Have students determine the force applied to the object using Newton’s laws of motion, work-energy theorem, and impulse-momentum theorem. The fourth square is a free-body diagram.</p>
2	4.3	<p>Desktop Experiment</p> <p>Give students two spring-loaded carts with different mass. First, have students determine the amount of kinetic energy gained by Cart 1 when launched by its spring. Then, have students make Cart 1 collide elastically with Cart 2 and predict where Cart 2 will land when it rolls off of the track.</p>
3	4.1	<p>Desktop Experiment</p> <p>Using two bathroom scales and a long wooden plank, have students determine the location of their center of mass. Have students determine how far their center of mass moves as they move their arms from their sides to up over their head.</p>
4	4.3	<p>Desktop Experiment</p> <p>Give students a device that fires a projectile much faster than can be measured directly using distance and time data. Students are to fire the projectile into a stationary, freely movable object; make necessary measurements; and use conservation of momentum to determine the launch speed of the projectile.</p>



Unit Planning Notes

Use the space below to plan your approach to the unit.

.....

.....

.....

SUGGESTED SKILLS

 *Mathematical Routines*

6.B Apply an appropriate law, definition, or mathematical relationship to solve a problem.



AVAILABLE RESOURCES

Classroom Resources >

- [AP Physics Featured Question: Projectile Concepts](#)
- [AP Physics Featured Question: Raft with Hanging Weights](#)
- [Critical Thinking Questions in Physics](#)
- [Physics Instruction Using Video Analysis Technology](#)
- [Quantitative Skills in the AP Sciences](#)
- [Teaching Strategies for Limited Class Time](#)

TOPIC 4.1

Center of Mass

Required Course Content

ENDURING UNDERSTANDING

CHA-3

The linear motion of a system can be described by the displacement, velocity, and acceleration of its center of mass.

LEARNING OBJECTIVE

CHA-3.A

- a. Calculate the center of mass of a system of point masses or a system of regular symmetrical objects.
- b. Calculate the center of mass of a thin rod of nonuniform density using integration.

ESSENTIAL KNOWLEDGE

CHA-3.A.1

A symmetrical, regular solid of uniform mass density has a center of mass at its geometric center.

- a. For a nonuniform solid that can be considered as a collection of regular masses or for a system of masses:

$$x_{cm} = \frac{\sum m_i x_i}{\sum m_i}$$

- b. The calculus definition is:

$$x_{cm} = \frac{\int x dm}{\int dm}$$

continued on next page

LEARNING OBJECTIVE

CHA-3.B

Describe the motion of the center of the mass of a system for various situations.

CHA-3.C

Explain the difference between the terms “center of gravity” and “center of mass,” and identify physical situations when these terms have identical positions and when they have different positions.

ESSENTIAL KNOWLEDGE

CHA-3.B.1

If there is no net force acting on an object or a system, the center of mass does not accelerate; therefore, the velocity of the center of mass remains unchanged.

- A system of multiple objects can be represented as one single mass with a position represented by the center of mass.
- The linear motion of a system can be described by the displacement, velocity, and acceleration of its center of mass.

CHA-3.C.1

The center of gravity is not precisely the same scientific quantity as the center of mass. If the object experiencing a gravitational interaction with a large planet is of large dimensions (comparable to the planet), then the gravitational acceleration due to the large planet will be a nonuniform value over the length of the object. This would result in the center of gravity location being a different location than the center of mass.

SUGGESTED SKILLS

 *Visual Representations*

1.C Demonstrate consistency between different types of representations of the same physical situation.

 *Question and Method*

2.C Identify appropriate experimental procedures to test a claim or prediction (which may include a sketch of a lab setup).

 *Theoretical Relationships*

5.D Determine or estimate the change in a quantity using a mathematical relationship.



AVAILABLE RESOURCES

Classroom Resources >

- [AP Physics Featured Question: Projectile Concepts](#)
- [AP Physics Featured Question: Raft with Hanging Weights](#)
- [Critical Thinking Questions in Physics](#)
- [Physics Instruction Using Video Analysis Technology](#)
- [Quantitative Skills in the AP Sciences](#)
- [Teaching Strategies for Limited Class Time](#)

TOPIC 4.2

Impulse and Momentum

Required Course Content

ENDURING UNDERSTANDING

INT-5

An impulse exerted on an object will change the linear momentum of the object.

LEARNING OBJECTIVE

INT-5.A

- a. Calculate the total momentum of an object or a system of objects.
- b. Calculate relationships between mass, velocity, and linear momentum of a moving object.

INT-5.B

Calculate the quantities of force, time of collision, mass, and change in velocity from an expression relating impulse to change in linear momentum for a collision of two objects.

ESSENTIAL KNOWLEDGE

INT-5.A.1

For a single object moving with some velocity, momentum is defined as:

$$\vec{p} = m\vec{v}$$

- a. The total momentum of the system is the vector sum of the momenta of the individual objects. The rate of change of momentum is equal to the net external force.

$$\vec{F} = \frac{d\vec{p}}{dt}$$

INT-5.B.1

Impulse is defined as the average force acting over a time interval:

$$\vec{J} = \vec{F}_{avg} \Delta t$$

- a. Impulse is also equivalent to the change in momentum of the object receiving the impulse.

$$\int \vec{F} dt = \Delta\vec{p} = \vec{J}$$

continued on next page

LEARNING OBJECTIVE

INT-5.C

Describe relationships between a system of objects' individual momenta and the velocity of the center of mass of the system of objects.

INT-5.D

Calculate the momentum change in a collision using a force versus time graph for a collision.

INT-5.E

Calculate the change in momentum of an object given a nonlinear function, $F(t)$, for a net force acting on the object.

ESSENTIAL KNOWLEDGE

INT-5.C.1

A collection of objects with individual momenta can be described as one system with one center of mass velocity.

INT-5.D.1

Impulse is equivalent to the area under a force versus time graph.

INT-5.E.1

Momentum changes can be calculated using the calculus relationship for impulse:

$$\vec{J} = \Delta\vec{p} = \int \vec{F} dt$$

SUGGESTED SKILLS

 *Visual Representations*

1.E Describe the effects of modifying conditions or features of a representation of a physical situation.

 *Theoretical Relationships*

5.E Derive a symbolic expression from known quantities by selecting and following a logical algebraic pathway.

 *Argumentation*

7.D Provide reasoning to justify a claim using physical principles or laws.

7.E Explain the connection between experimental results and larger physical principles, laws, or theories.

7.F Explain how potential sources of experimental error may affect results and/or conclusions.



AVAILABLE RESOURCES

Classroom Resources >

- [AP Physics Featured Question: Projectile Concepts](#)
- [AP Physics Featured Question: Raft with Hanging Weights](#)
- [Critical Thinking Questions in Physics](#)
- [Physics Instruction Using Video Analysis Technology](#)
- [Quantitative Skills in the AP Sciences](#)
- [Teaching Strategies for Limited Class Time](#)

TOPIC 4.3

Conservation of Linear Momentum, Collisions

Required Course Content

ENDURING UNDERSTANDING

CON-4

In the absence of an external force, the total momentum within a system can transfer from one object to another without changing the total momentum in the system.

LEARNING OBJECTIVE

CON-4.A

- a. Calculate the velocity of one part of a system after an explosion or a collision of the system.
- b. Calculate energy changes in a system that undergoes a collision or an explosion.

CON-4.B

Calculate the changes of momentum and kinetic energy as a result of a collision between two objects.

ESSENTIAL KNOWLEDGE

CON-4.A.1

Total momentum is conserved in the system and momentum is conserved in each direction in the absence of an external force.

CON-4.B.1

In the absence of an external force, momentum is always conserved.

- a. Kinetic energy is only conserved in elastic collisions.
- b. In an inelastic collision, some kinetic energy is transferred to internal energy of the system.

LEARNING OBJECTIVE

CON-4.C

Describe the quantities that are conserved in a collision.

CON-4.D

Calculate the speed of the center of mass of a system.

CON-4.E

- Calculate the changes in speeds, changes in velocities, changes in kinetic energy, or changes in momenta of objects in all types of collisions (elastic or inelastic) in one dimension, given the initial conditions of the objects.
- Derive expressions for the conservation of momentum for a particular collision in one dimension.

CON-4.F

- Calculate the changes in speeds, changes in velocities, changes in kinetic energy, or changes in momenta of objects involved in a two-dimensional collision (including an elastic collision), given the initial conditions of the objects.
- Derive expressions for the conservation of momentum for a particular two-dimensional collision of two objects.

ESSENTIAL KNOWLEDGE

CON-4.C.1

Momentum is a vector quantity.

- Momentum in each dimension is conserved in the absence of a net external force exerted on the object or system.
- Kinetic energy is conserved only if the collision is totally elastic.

CON-4.D.1

Forces internal to a system do not change the momentum of the center of mass.

CON-4.E.1

Conservation of momentum states that the momentum of a system remains constant when there are no external forces exerted on the system.

- Momentum is a vector quantity.
- An elastic collision is defined as a system where the total kinetic energy is conserved in the collision.

CON-4.F.1

In the absence of a net external force during an interaction, linear momentum is conserved.

- Momentum is a vector quantity. The momenta in each dimension (horizontal and vertical) are also conserved.
- Using momentum components can be useful in this approach.

THIS PAGE IS INTENTIONALLY LEFT BLANK.

AP PHYSICS C: MECHANICS

UNIT 5

Rotation



14–20%
AP EXAM WEIGHTING



~10/~20
CLASS PERIODS

The icon consists of a white circle containing a blue square with the letters 'AP' in white. Below the square are two horizontal lines, suggesting a computer screen or a digital interface.

AP

Remember to go to [AP Classroom](#) to assign students the online **Personal Progress Check** for this unit.

Whether assigned as homework or completed in class, the **Personal Progress Check** provides each student with immediate feedback related to this unit's topic and skills.

Personal Progress Check 5

Multiple-Choice: ~20 questions

Free-Response: 1 question

Rotation



Developing Understanding

BIG IDEA 2

Force Interactions **INT**

- Why does a curveball take less time to reach the plate than a fastball?
- Why is it easier to balance a bicycle when it's in motion?

BIG IDEA 4

Conservation **CON**

- How can you increase your swing on a swing set without being pushed?

In this unit, students will investigate torque and rotational statics, kinematics, and dynamics, in addition to angular momentum and its conservation, to gain an in-depth and comprehensive understanding of rotation. Students are provided with opportunities to make connections between the content and models explored in the first four units, as well as with opportunities to demonstrate the analogy between translational and rotational kinematics. Unfortunately, when dealing with rotational motion, all the conceptual difficulties found in translational motion also have direct analogs. For example, if the angular velocity is zero, students often believe that the angular acceleration must also be zero. Astronomical phenomena (such as satellites in orbit) are explored in Unit 7 to build students' knowledge of angular momentum and its conservation.

Building the Science Practices

3.C 5.D 6.D

In this unit, students will create and use graphical representations to demonstrate understanding of the functional relationships between the variables that describe the motion of objects or systems. The content of Unit 5 provides students with multiple opportunities to discuss the relationships between variables and to graph these relationships in various scenarios.

Unit 5 will also help students master clear and concise derivations of a change in quantity using mathematical relationships. On the AP Exam, students should be comfortable with calculating an unknown quantity with units, and/or a symbolic expression from known quantities, by selecting and following a logical computational pathway. Students should also be able to assess the reasonableness of their results or solutions and will be expected to derive and/or calculate on the free-response section on the AP Physics C: Mechanics Exam.

Preparing for the AP Exam

To earn full credit on a free-response question, students must be able to describe and modify their assumptions about a representation of a physical situation. They should also be able to determine the change in a quantity using a mathematical relationship and calculate a symbolic expression from known quantities. For example, students should be able to determine the change in angular momentum after torque has been applied to a pulley.

Calculating an unknown quantity with units, and/or a symbolic expression from known quantities, by selecting and following a logical computational pathway is also required. For example, students must be able to calculate the angular acceleration of a hoop rolling without sliding down an incline. Quite often when prompted to "calculate," students will fail to properly show all mathematical work. They should start with a known physics formula and show, step-by-step (including numeric substitutions), how a final answer is achieved.

UNIT AT A GLANCE

Enduring Understanding	Topic	Suggested Skills	Class Periods
			~10/~20 CLASS PERIODS
INT-6	5.1 Torque and Rotational Statics	<p>2.D Make observations or collect data from representations of laboratory setups or results.</p> <p>3.B Represent features of a model or the behavior of a physical system using appropriate graphing techniques, appropriate scale, and units.</p>	
CHA-4	5.2 Rotational Kinematics	<p>2.B Make a claim or predict the results of an experiment.</p> <p>5.B Determine the relationship between variables within an equation when an existing variable changes.</p> <p>6.C Calculate an unknown quantity with units from known quantities, by selecting and following a logical computational pathway.</p>	
INT-7	5.3 Rotational Dynamics and Energy	<p>1.E Describe the effects of modifying conditions or features of a representation of a physical situation.</p> <p>3.C Sketch a graph that shows a functional relationship between two quantities.</p> <p>4.D Select relevant features of a graph to describe a physical situation or solve problems.</p> <p>5.D Determine or estimate the change in a quantity using a mathematical relationship.</p>	
CON-5	5.4 Angular Momentum and Its Conservation	<p>1.E Describe the effects of modifying conditions or features of a representation of a physical situation.</p> <p>5.E Derive a symbolic expression from known quantities by selecting and following a logical algebraic pathway.</p> <p>6.D Assess the reasonableness of results or solutions.</p> <p>7.D Provide reasoning to justify a claim using physical principles or laws.</p>	
<p> Go to AP Classroom to assign the Personal Progress Check for Unit 5. Review the results in class to identify and address any student misunderstandings.</p>			

SAMPLE INSTRUCTIONAL ACTIVITIES

The sample activities on this page are optional and are offered to provide possible ways to incorporate instructional approaches into the classroom. Teachers do not need to use these activities or instructional approaches and are free to alter or edit them. The examples below were developed in partnership with teachers from the AP community to share ways that they approach teaching some of the topics in this unit. Please refer to the Instructional Approaches section beginning on p. 115 for more examples of activities and strategies.

Activity	Topic	Sample Activity
1	5.3	<p>Desktop Experiment</p> <p>Students allow a yo-yo to fall and unroll. Have them use a meterstick and stopwatch to determine its downward acceleration. Also have them measure its mass and the radius of its axle and use that information to determine the yo-yo's rotational inertia using rotational dynamics.</p>
2	5.3	<p>Desktop Experiment</p> <p>Have students release a yo-yo from the top of a ramp and allow it to roll down the ramp. Have them use a meterstick and stopwatch to determine the yo-yo's final velocity and the height of its release. Next, have them measure the yo-yo's outer radius and mass and use that information to determine the yo-yo's rotational inertia using energy concepts.</p>
3	5.4	<p>Create a Plan</p> <p>Have students complete the necessary research to determine the rotational inertia of a human body in different configurations (arms outstretched, arms pulled in, for example). Then, obtain footage of a figure skater spinning and pulling in her his/arms. Have students analyze the footage to see if angular momentum is conserved.</p>
4	5.3	<p>Bar Chart</p> <p>Have students a hoop and a disk (equal mass and radius) down identical ramps. Then have them explain why the disk reached the bottom in less time using energy bar charts and to-scale free-body diagrams.</p>
5	5.1	<p>Identify Subtasks</p> <p>Have students design a walkway (of given mass) that is to be suspended from a ceiling. Have them determine the amount of force the two supports (one on each end) must be able to provide as a person (of given mass) walks across the walkway.</p>



Unit Planning Notes

Use the space below to plan your approach to the unit.

.....

.....

.....

SUGGESTED SKILLS

 Question and Method

2.D Make observations or collect data from representations of laboratory setups or results.

 Representing Data and Phenomena

3.B Represent features of a model or the behavior of a physical system using appropriate graphing techniques, appropriate scale, and units.



AVAILABLE RESOURCES

Classroom Resources >

- [AP Physics Featured Question: Projectile Concepts](#)
- [AP Physics Featured Question: Raft with Hanging Weights](#)
- [Critical Thinking Questions in Physics](#)
- [Physics Instruction Using Video Analysis Technology](#)
- [Quantitative Skills in the AP Sciences](#)
- [Teaching Strategies for Limited Class Time](#)

TOPIC 5.1

Torque and Rotational Statics

Required Course Content

ENDURING UNDERSTANDING

INT-6

When a physical system involves an extended rigid body, there are two conditions of equilibrium—a translational condition and a rotational condition.

LEARNING OBJECTIVE

INT-6.A

- a. Calculate the magnitude and direction of the torque associated with a given force acting on a rigid body system.
- b. Calculate the torque acting on a rigid body due to the gravitational force.

ESSENTIAL KNOWLEDGE

INT-6.A.1

The definition of torque is:

$$\vec{\tau} = \vec{r} \times \vec{F}$$

- a. Torque is a vector product (or cross-product), and it has a direction that can be determined by the vector product or by applying the appropriate right-hand rule.
- b. The idea of the “moment-arm” is useful when computing torque. The moment arm is the perpendicular distance between the pivot point and the line of action of the point of application of the force. The magnitude of the torque vector is equivalent to the product of the moment arm and the force.

continued on next page

LEARNING OBJECTIVE**INT-6.B**

- Describe the two conditions of equilibrium for an extended rigid body.
- Calculate unknown magnitudes and directions of forces acting on an extended rigid body that is in a state of translational and rotational equilibrium.

INT-6.C

- Explain the differences in the moments of inertia between different objects such as rings, discs, spheres, or other regular shapes by applying the general definition of moment of inertia (rotational inertia) of a rigid body.
- Calculate by what factor an object's rotational inertia will change when a dimension of the object is changed by some factor.
- Calculate the moment of inertia of point masses that are located in a plane about an axis perpendicular to the plane.

ESSENTIAL KNOWLEDGE**INT-6.B.1**

The two conditions of equilibrium are:

- $$\sum \vec{F} = 0$$
- $$\sum \vec{\tau} = 0$$
- Both conditions must be satisfied for an extended rigid body to be in equilibrium.

INT-6.C.1

The general definition of moment of inertia is:

$$I = \sum m_i r_i^2$$

continued on next page

LEARNING OBJECTIVE

INT-6.D

- Derive the moment of inertia, using calculus, of a thin rod of uniform density about an arbitrary axis perpendicular to the rod.
- Derive the moment of inertia, using calculus, of a thin rod of nonuniform density about an arbitrary axis perpendicular to the rod.
- Derive the moments of inertia for a thin cylindrical shell or disc about its axis or an object that can be considered to be made up of coaxial shells (e.g., annular ring).

INT-6.E

Derive the moments of inertia of an extended rigid body for different rotational axes (parallel to an axis that goes through the object's center of mass) if the moment of inertia is known about an axis through the object's center of mass.

ESSENTIAL KNOWLEDGE

INT-6.D.1

The calculus definition of moment of inertia is:

$$I = \int r^2 dm$$

- The differential dm must be determined from the linear mass density of the rod or object.

INT-6.E.1

The parallel axis theorem is a simple powerful theorem that allows the moments of inertia to be computed for an object through any axis that is parallel to an axis through its center of mass.

$$I' = I_{cm} + Md^2$$

TOPIC 5.2

Rotational Kinematics

Required Course Content

ENDURING UNDERSTANDING

CHA-4

There are relationships among the physical properties of angular velocity, angular position, and angular acceleration.

LEARNING OBJECTIVE

CHA-4.A

- Explain how the angular kinematic relationships for uniform angular acceleration are directly analogous to the relationships for uniformly and linearly accelerated motion.
- Calculate unknown quantities such as angular positions, displacement, angular speeds, or angular acceleration of a rigid body in uniformly accelerated motion, given initial conditions.
- Calculate unknown quantities such as angular positions, displacement, angular velocity, or rotational kinetic energy of a rigid body rotating with a specified nonuniform angular acceleration.

ESSENTIAL KNOWLEDGE

CHA-4.A.1

There are angular kinematic relationships for objects experiencing a uniform angular acceleration. These are the relationships:

$$\theta = \theta_0 + \omega_0 t + \frac{1}{2} \alpha t^2$$

$$\omega = \omega_0 + \alpha t$$

Other relationships can be derived from the above two relationships.

- The appropriate unit for angular position is radians.
- The general calculus kinematic linear relationships have analogous representations in rotational motion such as:

$$\omega = \frac{d\theta}{dt}$$

SUGGESTED SKILLS

 Question and Method

2.B Make a claim or predict the results of an experiment.

 Theoretical Relationships

5.B Determine the relationship between variables within an equation when an existing variable changes.

 Mathematical Routines

6.C Calculate an unknown quantity with units from known quantities, by selecting and following a logical computational pathway.



AVAILABLE RESOURCES

Classroom Resources >

- [AP Physics Featured Question: Projectile Concepts](#)
- [AP Physics Featured Question: Raft with Hanging Weights](#)
- [Critical Thinking Questions in Physics](#)
- [Physics Instruction Using Video Analysis Technology](#)
- [Quantitative Skills in the AP Sciences](#)
- [Teaching Strategies for Limited Class Time](#)

continued on next page

LEARNING OBJECTIVE**CHA-4.B**

- Explain the use of the relationships that connect linear translational motion to rotational motion in appropriate physical situations.
- Calculate the translational kinematic quantities from an object's rotational kinematic quantities for objects that are rolling without slipping.
- Calculate the (tangential) linear acceleration of a point on a rotating object given the object's angular acceleration.

ESSENTIAL KNOWLEDGE**CHA-4.B.1**

For objects that are rolling without slipping on a surface, the angular motion is related to the linear translational motion by the following relationships:

$$v = r\omega$$

$$a = r\alpha$$

$$\Delta x = r\Delta\theta$$

TOPIC 5.3

Rotational Dynamics and Energy

Required Course Content

ENDURING UNDERSTANDING

INT-7

A net torque acting on a rigid extended body will produce rotational motion about a fixed axis.

LEARNING OBJECTIVE

INT-7.A

- Describe the complete analogy between fixed axis rotation and linear translation for an object subject to a net torque.
- Calculate unknown quantities such as net torque, angular acceleration, or moment of inertia for a rigid body undergoing rotational acceleration.
- Calculate the angular acceleration of an extended rigid body, of known moment of inertia, about a fixed axis or about its center of mass when it is experiencing a specified net torque due to one or several applied forces.

ESSENTIAL KNOWLEDGE

INT-7.A.1

The rotational analog to Newton's second law is:

$$\bar{\alpha} = \frac{\sum \bar{\tau}}{I}$$

- In the appropriate cases, both laws (Newton's second law and the analogous rotational law) can be applied to a dynamic system and the two laws are independent from each other.

SUGGESTED SKILLS

 *Visual Representations*

1.E Describe the effects of modifying conditions or features of a representation of a physical situation.

 *Representing Data and Phenomena*

3.C Sketch a graph that shows a functional relationship between two quantities.

 *Data Analysis*

4.D Select relevant features of a graph to describe a physical situation or solve problems.

 *Theoretical Relationships*

5.D Determine or estimate the change in a quantity using a mathematical relationship.



AVAILABLE RESOURCES

Classroom Resources >

- [AP Physics Featured Question: Projectile Concepts](#)
- [AP Physics Featured Question: Raft with Hanging Weights](#)
- [Critical Thinking Questions in Physics](#)
- [Physics Instruction Using Video Analysis Technology](#)
- [Quantitative Skills in the AP Sciences](#)
- [Teaching Strategies for Limited Class Time](#)

continued on next page

LEARNING OBJECTIVE**INT-7.B**

- Describe the net torque experienced by a rigid extended body in situations such as, but not limited to, rolling down inclines, pulled along horizontal surfaces by external forces, a pulley system (with rotational inertia), simple pendulums, physical pendulums, and rotating bars.
- Derive an expression for all torques acting on a rigid body in various physical situations using Newton's second law of rotation.

INT-7.C

- Derive expressions for physical systems such as Atwood machines, pulleys with rotational inertia, or strings connecting discs or strings connecting multiple pulleys that relate linear or translational motion characteristics to the angular motion characteristics of rigid bodies in the system that are—
- rolling (or rotating on a fixed axis) without slipping.
 - rotating and sliding simultaneously.

ESSENTIAL KNOWLEDGE**INT-7.B.1**

- All real forces acting on an extended rigid body can be represented by a rigid body diagram. The point of application of each force can be indicated in the diagram.
- The rigid body diagram is helpful in applying the rotational Newton's second law to a rotating body.

INT-7.C.1

- A complete analysis of a dynamic system that is rolling without slipping can be performed by applying both of Newton's second laws properly to the system.
- The rotational characteristics may be related to the linear motion characteristics with the relationships listed in section CHA-4.A1 and CHA-4.B.1 (i.e., $v = r\omega$)
 - If the rigid body undergoing motion has a rotational component of motion and an independent translational motion (i.e., the object is slipping), then the rolling condition relationships do not hold.
- $$v \neq r\omega$$

continued on next page

LEARNING OBJECTIVE**INT-7.D**

- Calculate the rotational kinetic energy of a rotating rigid body.
- Calculate the total kinetic energy of a rolling body or a body that has both translation and rotational motion.
- Calculate the amount of work done on a rotating rigid body by a specified force applied to the rigid body over a specified angular displacement.

INT-7.E

Derive expressions using energy conservation principles for physical systems such as rolling bodies on inclines, Atwood machines, pendulums, physical pendulums, and systems with massive pulleys that relate linear or angular motion characteristics to initial conditions (such as height or position) or properties of rolling body (such as moment of inertia or mass).

ESSENTIAL KNOWLEDGE**INT-7.D.1**

The definition of rotational kinetic energy is:

$$K_R = \frac{1}{2} I \omega^2$$

- Total kinetic energy of a rolling body or a body with both forms of motion is the sum of each kinetic energy term.
- The definition of work also has an analogous form in rotational dynamics:

$$W = \int \tau d\theta$$

INT-7.E.1

If a rigid body is defined as “rolling,” this implies (in the ideal case) that the frictional force does no work on the rolling object. The consequence of this property is that in some special cases (such as a sphere rolling down an inclined surface), the conservation of mechanical energy can be applied to the system.

SUGGESTED SKILLS

 *Visual Representations*

1.E Describe the effects of modifying conditions or features of a representation of a physical situation.

 *Theoretical Relationships*

5.E Derive a symbolic expression from known quantities by selecting and following a logical algebraic pathway.

 *Mathematical Routines*

6.D Assess the reasonableness of results or solutions.

 *Argumentation*

7.D Provide reasoning to justify a claim using physical principles or laws.



AVAILABLE RESOURCES

Classroom Resources >

- [AP Physics Featured Question: Projectile Concepts](#)
- [AP Physics Featured Question: Raft with Hanging Weights](#)
- [Critical Thinking Questions in Physics](#)
- [Physics Instruction Using Video Analysis Technology](#)
- [Quantitative Skills in the AP Sciences](#)
- [Teaching Strategies for Limited Class Time](#)

TOPIC 5.4

Angular Momentum and Its Conservation

Required Course Content

ENDURING UNDERSTANDING

CON-5

In the absence of an external torque, the total angular momentum of a system can transfer from one object to another within the system without changing the total angular momentum of the system.

LEARNING OBJECTIVE

CON-5.A

- a. Calculate the angular impulse acting on a rotating rigid body given specified angular properties or forces acting over time intervals.
- b. Calculate the angular momentum vector of a rotating rigid body in cases in which the vector is parallel to the angular velocity vector.

ESSENTIAL KNOWLEDGE

CON-5.A.1

The definition of angular momentum of a rotating rigid body is:

$$\vec{L} = I\vec{\omega}$$

- a. Angular impulse is equivalent to the change in angular momentum. The definition of this relationship is:

$$\int \vec{\tau} dt = \Delta\vec{L}$$

- b. The differential definition is:

$$\vec{\tau} = \frac{d\vec{L}}{dt}$$

continued on next page

LEARNING OBJECTIVE**CON-5.B**

Calculate the angular momentum vector of a linearly translating particle about a defined stationary point of reference.

CON-5.C

- Describe the conditions under which a rotating system's angular momentum is conserved.
- Explain how a one- or two-particle system (rotating object or satellite orbits) may have a change in angular velocity when other properties of the system change (such as radius or inertia).

CON-5.D

- Calculate changes in angular velocity of a rotating rigid body when the moment of inertia of the body changes during the motion (such as a satellite in orbit).
- Calculate the increase or decrease in angular momentum of a rigid body when a point mass particle has a collision with the rigid body.
- Calculate the changes of angular momentum of each disc in a rotating system of two rotating discs that collide with each other inelastically about a common rotational axis.

ESSENTIAL KNOWLEDGE**CON-5.B.1**

The angular momentum of a linearly translating particle can be defined about some arbitrary point of reference or origin. The definition is:

$$\vec{L} = \vec{r} \times \vec{p}$$

- The direction of this particle's angular momentum is determined by the vector product (cross-product).

CON-5.C.1

In the absence of external torques acting on a rotating body or system, the total angular momentum of the system is a constant.

CON-5.D.1

The conservation of angular momentum can be applied to many types of physical situations. In all cases, it must be determined that there is no net external torque on the system.

- In the case of collisions (such as two discs colliding with each other), the torques applied to each disc are "internal" if the system is considered to be the two discs.
- In the case of a particle colliding with a rod or physical pendulum, the system is considered to be the particle and the rod together.

THIS PAGE IS INTENTIONALLY LEFT BLANK.

AP PHYSICS C: MECHANICS

UNIT 6

Oscillations



6–14%
AP EXAM WEIGHTING



~5/~10
CLASS PERIODS

The icon consists of a white circle containing a blue square with the letters 'AP' in white. Below the square are two horizontal lines, suggesting a computer screen or a digital interface.

AP

Remember to go to [AP Classroom](#) to assign students the online **Personal Progress Check** for this unit.

Whether assigned as homework or completed in class, the **Personal Progress Check** provides each student with immediate feedback related to this unit's topic and skills.

Personal Progress Check 6

Multiple-Choice: ~10 questions

Free-Response: 1 question

Oscillations



Developing Understanding

BIG IDEA 2 **ACT**

- How does the presence of restoring forces predict and lead to harmonic motion?

While earlier units focused on linear motion, Unit 6 pays close attention to the type of motion we experience when we talk or listen to music. Through the concept of oscillations, students are introduced to the model of simple harmonic motion (SHM), springs, and pendulums. Students will discover why some objects repeat their motions with a regular pattern. They will also apply the model of SHM, define the three kinematic characteristics (displacement, velocity, and acceleration), and practice representing them graphically and mathematically. During their study of oscillations, students will gain a more in-depth understanding of motion, making them better equipped to apply their knowledge of forces and motion to waves. Students will continue to expand on circular motion in Unit 7 as they explore celestial bodies and objects.

Building the Science Practices

4.C 4.E 7.F

Linearizing data is an important skill that helps students to re-express data, see functional relationships, and write equations between variables. Regular analysis of data collected in the laboratory, as well as laboratory type data, will strengthen students' linearization and data analysis skills.

Representations exist to make describing, explaining, and analyzing phenomena more manageable. It is vital that students are given multiple opportunities to represent data to be able to discuss how that data or graph illustrates physics principles, processes, concepts, or theories.

Unit 6 will continue to develop the practice of writing clear and concise laboratory observations and data collection, as well as identifying and/or describing potential sources of experimental error. Students should have multiple opportunities every unit to perform laboratory investigations, particularly inquiry-based investigations where they are challenged to think about, discuss, and analyze the potential sources

of error and how each error affects the results of the experiment.

Preparing for the AP Exam

One of the free-response questions may require students to create graphs, free-body and free-body force diagrams, or other representations. Students often fail to create effective graphs due to an inability to choose appropriate quantities and labels (with units), a useful scale, correctly plot given data points, and draw a best-fit line. These elements must be performed correctly to receive full credit. Additionally, students must be adept at working with graphs (creation, analysis, interpreting, etc.) and constructing coherent arguments for them or other phenomena. For example, justifying the claim that an object is experiencing a restoring force based on the analysis of its motion and comparison to SHM.

Some students also struggle with correctly drawing free-body diagrams. It's recommended that students have ample practice and opportunities to practice this skill. For example, when drawing free-body force diagrams, students should pay careful attention to including appropriate forces and correct relative vector lengths.

UNIT AT A GLANCE

Enduring Understanding	Topic	Suggested Skills	Class Periods
INT-8	6.1 Simple Harmonic Motion, Springs, and Pendulums	<p>1.E Describe the effects of modifying conditions or features of a representation of a physical situation.</p> <p>2.B Make a claim or predict the results of an experiment.</p> <p>2.F Explain modifications to an experimental procedure that will alter results.</p> <p>4.C Linearize data and/or determine a best fit line or curve.</p> <p>4.E Explain how the data or graph illustrates a physics principle, process, concept, or theory.</p> <p>5.E Derive a symbolic expression from known quantities by selecting and following a logical algebraic pathway.</p> <p>7.F Explain how potential sources of experimental error may affect results and/or conclusions.</p>	~5/~10 CLASS PERIODS
	<p>Go to AP Classroom to assign the Personal Progress Check for Unit 6. Review the results in class to identify and address any student misunderstandings.</p>		

SAMPLE INSTRUCTIONAL ACTIVITIES

The sample activities on this page are optional and are offered to provide possible ways to incorporate instructional approaches into the classroom. Teachers do not need to use these activities or instructional approaches and are free to alter or edit them. The examples below were developed in partnership with teachers from the AP community to share ways that they approach teaching some of the topics in this unit. Please refer to the Instructional Approaches section beginning on p. 115 for more examples of activities and strategies.

Activity	Topic	Sample Activity
1	6.1	<p>Changing Representations</p> <p>Students are given a graph of position/velocity/acceleration for SHM and must make the other three graphs with the same time scale, along with force, momentum, kinetic energy, potential energy, and total energy versus time graphs. The students must also make energy bar charts for various instants during the SHM.</p>
2	6.1	<p>Desktop Experiment</p> <p>Obtain a steel ruler or yardstick, clamp it to a table, and attach various masses to the end with the hole in it. Have students measure the period of oscillation for each mass attached, and then use the data to determine the spring constant of the steel ruler.</p>
3	6.1	<p>Desktop Experiment</p> <p>Have students use a pendulum to determine the acceleration of gravity in the classroom. The winners are the group whose procedure includes the most components for reducing error (timing multiple periods, linearizing data, very precisely finding the center of mass of the bob, for example).</p>
4	6.1	<p>Ranking</p> <p>Give students four to six cases of a mass on a spring. The cases show different masses, spring constants, and oscillation amplitudes ($m/k/2A$, $m/2k/A$, and $2m/k/2A$, for example). Have students rank them based on period, frequency, maximum speed, maximum acceleration, maximum force, and total energy.</p>
5	6.1	<p>Predict and Explain</p> <p>Have students predict whether a ball rolling back and forth inside a spherical bowl is SHM. Have them take data to show whether this is SHM (period independent of amplitude or motion is a sine function or force proportional to displacement).</p>



Unit Planning Notes

Use the space below to plan your approach to the unit.

.....

.....

.....

SUGGESTED SKILLS

 *Visual Representations*

1.E Describe the effects of modifying conditions or features of a representation of a physical situation.

 *Question and Method*

2.B Make a claim or predict the results of an experiment.

2.F Explain modifications to an experimental procedure that will alter results.

 *Data Analysis*

4.C Linearize data and/or determine a best fit line or curve.

4.E Explain how the data or graph illustrates a physics principle, process, concept, or theory.

 *Theoretical Relationships*

5.E Derive a symbolic expression from known quantities by selecting and following a logical algebraic pathway.

 *Argumentation*

7.F Explain how potential sources of experimental error may affect results and/or conclusions.



AVAILABLE RESOURCES

Classroom Resources >

- [AP Physics Featured Question: Projectile Concepts](#)
- [AP Physics Featured Question: Raft with Hanging Weights](#)
- [Critical Thinking Questions in Physics](#)
- [Physics Instruction Using Video Analysis Technology](#)
- [Quantitative Skills in the AP Sciences](#)
- [Teaching Strategies for Limited Class Time](#)

TOPIC 6.1

Simple Harmonic Motion, Springs, and Pendulums

Required Course Content

ENDURING UNDERSTANDING

INT-8

There are certain types of forces that cause objects to repeat their motions with a regular pattern.

LEARNING OBJECTIVE

INT-8.A

- a. Describe the general behavior of a spring-mass system in SHM in qualitative terms.
- b. Describe the relationship between the phase angle and amplitude in an SHM system.

INT-8.B

- a. Describe the displacement in relation to time for a mass-spring system in SHM.
- b. Identify the period, frequency, and amplitude of the SHM in a mass-spring system from the features of a plot.

ESSENTIAL KNOWLEDGE

INT-8.A.1

The general relationship for SHM is given by the following relationship:

$$x = x_{\max} \cos(\omega t + \varphi)$$

φ is the phase angle and x_{\max} is the amplitude of the oscillation. This expression can be simplified given initial conditions of the system.

INT-8.B.1

The period of SHM is related to the angular frequency by the following relationship:

$$T = \frac{2\pi}{\omega} = \frac{1}{f}$$

continued on next page

LEARNING OBJECTIVE**INT-8.C**

Describe each of the three kinematic characteristics of a spring-mass system in SHM in relation to time (displacement, velocity, and acceleration). For a spring-mass system in SHM—

- describe the general features of the motion and
- identify the places on a graph where these values are zero or have maximum positive values or maximum negative values.

INT-8.D

Derive a differential equation to describe Newton's second law for a spring-mass system in SHM or for the simple pendulum.

INT-8.E

Calculate the position, velocity, or acceleration of a spring-mass system in SHM at any point in time or at any known position from the initial conditions and known spring constant and mass.

ESSENTIAL KNOWLEDGE**INT-8.C.1**

Using calculus and the position in relation to time relationship for an object in SHM, all three kinematic characteristics can be explored. Recognizing the positions or times where the trigonometric functions have extrema or zeroes can provide more detail in qualitatively describing the behavior of the motion.

INT-8.D.1

Using Newton's second law, the following characteristic differential equation of SHM can be derived:

$$\frac{d^2x}{dt^2} = -\omega^2x$$

The physical characteristics of the spring-mass system (or pendulum) can be determined from the differential relationship.

INT-8.E.1

All of the characteristics of motion in SHM can be determined by using the general relationship $x = x_{\max} \cos(\omega t + \varphi)$ and calculus relationships.

continued on next page

LEARNING OBJECTIVE

INT-8.F

Derive the expression for the period of oscillation for various physical systems oscillating in SHM.

INT-8.G

Calculate the mechanical energy of an oscillating system. Show that this energy is conserved in an ideal SHM spring-mass system.

INT-8.H

Describe the effects of changing the amplitude of a spring-mass system.

ESSENTIAL KNOWLEDGE

INT-8.F.1

The period can be derived from the characteristic differential equation. The following types of SHM systems can be explored:

- Mass oscillating on spring in vertical orientation
- Mass oscillating on spring in horizontal orientation
- Mass-spring system with springs in series or parallel
- Simple pendulum
- Physical pendulum
- Torsional pendulum

INT-8.G.1

Potential energy can be calculated using the spring constant and the displacement from equilibrium of a mass-spring system:

$$U_s = \frac{1}{2}k(\Delta x)^2$$

- Mechanical energy is always conserved in an ideal oscillating spring-mass system.
- Maximum potential energy occurs at maximum displacement, where velocity is zero and kinetic energy is zero. This maximum potential energy is equivalent to the total mechanical energy of the system.
- These energy relationships are true in the following three types of SHM systems:
 - Mass-spring in horizontal orientation
 - Mass-spring in vertical orientation
 - Simple pendulum

INT-8.H.1

Total energy of a spring-mass system is proportional to the square of the amplitude.

$$E_{total} = \frac{1}{2}kA^2 = \frac{1}{2}kx_{max}^2$$

- The total energy is composed of the two contributing mechanical energies of the spring-mass system.

$$E_{total} = K + U_s$$

continued on next page

LEARNING OBJECTIVE**INT-8.I**

Describe the kinetic energy as a function of time (or position), potential energy as a function of time (or position), and total mechanical energy as a function of time (or position) for a spring-mass system in SHM, identifying important features of the oscillating system and where these features occur.

INT-8.J

Explain how the model of SHM can be used to determine characteristics of motion for other physical systems that can exhibit this behavior.

INT-8.K

Describe a linear relationship between the period of a system oscillating in SHM and physical constants of the system.

ESSENTIAL KNOWLEDGE**INT-8.I.1**

The total mechanical energy of a system in SHM is conserved. The potential energy of the spring-mass system is:

$$U_s = \frac{1}{2}k(\Delta x)^2$$

and the kinetic energy of the system is:

$$K = \frac{1}{2}mv^2$$

The total energy in the system is defined above in **INT-8.H.1**.

INT-8.J.1

Any physical system that creates a linear restoring force ($\vec{F}_{rest} = -k\Delta\vec{x}$) will exhibit the characteristics of SHM.

INT-8.K.1

The period of a system oscillating in SHM is:

$$T_s = 2\pi\sqrt{\frac{m}{k}}$$

(or its equivalent for a pendulum or physical pendulum) and this can be shown to be true experimentally from a plot of the appropriate data.

$$T_p = 2\pi\sqrt{\frac{l}{g}}$$

THIS PAGE IS INTENTIONALLY LEFT BLANK.

AP PHYSICS C: MECHANICS

UNIT 7

Gravitation



6–14%
AP EXAM WEIGHTING



~5/~10
CLASS PERIODS

The icon consists of a white circle containing a blue square with the letters 'AP' in white. Below the square are two horizontal lines, suggesting a computer screen or a digital interface.

Remember to go to [AP Classroom](#) to assign students the online **Personal Progress Check** for this unit.

Whether assigned as homework or completed in class, the **Personal Progress Check** provides each student with immediate feedback related to this unit's topic and skills.

Personal Progress Check 7

Multiple-Choice: ~10 questions

Free-Response: 1 question

Gravitation



Developing Understanding

BIG IDEA 3

Fields **FLD**

- How does the moon stay in orbit despite its great distance from the Earth?

BIG IDEA 4

Conservation **CON**

- Why is navigation technology dependent on the orbits of Earth's artificial satellites?

Unit 7 investigates Newton's laws of gravity and the relationships shared between planets, satellites, and their orbits. Students will become familiar with the law of universal gravitation and how it can be applied to any pair of masses and will consider the motion of an object in orbit under the influence of gravitational forces. Additionally, students will be given opportunities to relate connected knowledge across units by applying and deriving Kepler's laws of planetary motion to circular or general orbits. Drawing such relationships will help elevate students' understanding of motion and force in various circumstances.

Building the Science Practices

5.E 1.D 3.D

At this point in the course, students should be skilled at crafting clear and concise derivations that utilize fundamental principles of physics and follow a clear and logical algebraic pathway. Students should also be able to assess the feasibility of their solutions by checking units and functional relationships to determine if their solution is correct. This is an especially important skill when performing derivations, as the solution is often something that looks "messy" and is difficult to assess without practice.

As students progress, they should become more proficient at selecting and creating relevant representations (e.g., free-body diagrams) to answer a question or defend claims, illustrate physical situations, solve problems, and show consistency between multiple sets of representations of the same physical scenario.

Preparing for the AP Exam

Students should be able to assess the reasonableness of solutions. For gravity-based problems, they must be able to assess whether 500 kg is a reasonable solution for the mass of the sun or the mass of a person. They should also be able to construct a logical and coherent argument (or aspects of one) that supports their assessment or any other phenomena. Aspects or elements of an argument include explanations, predictions, and justifications.

Teachers should provide ample time and practice for students to develop and/or evaluate an argument using scientific reasoning that connects their claim and evidence; assumptions and limitations should also be considered. For example, students should be able to develop an explanation that supports the assertion that there exists in the space between two massive bodies a point where the net gravitational force on a test object is zero. Student explanations must always include a claim supported by evidence and reasoning.

**UNIT
7**

Gravitation

UNIT AT A GLANCE

Enduring Understanding	Topic	Suggested Skills	Class Periods
FLD-1	7.1 Gravitational Forces	<p>3.D Create appropriate diagrams to represent physical situations.</p> <p>4.E Explain how the data or graph illustrates a physics principle, process, concept, or theory.</p> <p>5.E Derive a symbolic expression from known quantities by selecting and following a logical algebraic pathway.</p>	~5/~10 CLASS PERIODS
CON-6	7.2 Orbits of Planets and Satellites	<p>3.C Sketch a graph that shows a functional relationship between two quantities.</p> <p>5.D Determine or estimate the change in a quantity using a mathematical relationship.</p> <p>6.C Calculate an unknown quantity with units from known quantities by selecting and following a logical computational pathway.</p> <p>7.F Explain how potential sources of experimental error may affect results and/or conclusions.</p>	
<p>Go to AP Classroom to assign the Personal Progress Check for Unit 7. Review the results in class to identify and address any student misunderstandings.</p>			

SAMPLE INSTRUCTIONAL ACTIVITIES

The sample activities on this page are optional and are offered to provide possible ways to incorporate instructional approaches into the classroom. Teachers do not need to use these activities or instructional approaches and are free to alter or edit them. The examples below were developed in partnership with teachers from the AP community to share ways that they approach teaching some of the topics in this unit. Please refer to the Instructional Approaches section beginning on p. 115 for more examples of activities and strategies.

Activity	Topic	Sample Activity
1	7.1	<p>Identify Subtasks</p> <p>Have students research the structure of the Earth (specifically the density and depth of the various layers of the Earth: crust, mantle, outer core, inner core) and then calculate what the gravitational field strength must be at the boundary of each layer.</p>
2	7.1	<p>Predict and Explain</p> <p>Have students predict whether an object dropped into a hole drilled into a uniformly-dense, non-rotating planet exhibits simple harmonic motion. Have students show that it does (because the gravitational force is proportional to displacement from the center).</p>
3	7.2	<p>Bar Chart</p> <p>Have students create an energy bar-chart for an actual comet or asteroid that orbits the sun. Next, have them research the orbital parameters of the asteroid to make to-scale bar charts. The perihelion should be between 20% and 70% of the aphelion.</p>
4	7.2	<p>Desktop Experiment</p> <p>Have students use the My Solar System PhET applet to establish a circular orbit of a planet whose mass is very small compared to the central star. Trying various combinations of radius, speed, star mass, and planet mass (always making a circular orbit), have students show evidence of Newton's Law of Universal Gravitation.</p>
5	7.2	<p>Desktop Experiment</p> <p>Have students use the My Solar System PhET applet to establish a circular orbit of a planet whose mass is very small compared to the central star. Trying various combinations of radius and speed (always making a circular orbit), have students show evidence of Kepler's Third Law.</p>



Unit Planning Notes

Use the space below to plan your approach to the unit.

.....

.....

.....

SUGGESTED SKILLS

 *Representing Data and Phenomena*

3.D Create appropriate diagrams to represent physical situations.

 *Data Analysis*

4.E Explain how the data or graph illustrates a physics principle, process, concept, or theory.

 *Theoretical Relationships*

5.E Derive a symbolic expression from known quantities by selecting and following a logical algebraic pathway.



AVAILABLE RESOURCES

Classroom Resources >

- [AP Physics Featured Question: Projectile Concepts](#)
- [AP Physics Featured Question: Raft with Hanging Weights](#)
- [Critical Thinking Questions in Physics](#)
- [Physics Instruction Using Video Analysis Technology](#)
- [Quantitative Skills in the AP Sciences](#)
- [Teaching Strategies for Limited Class Time](#)

TOPIC 7.1

Gravitational Forces

Required Course Content

ENDURING UNDERSTANDING

FLD-1

Objects of large mass will cause gravitational fields that create an interaction at a distance with other objects with mass.

LEARNING OBJECTIVE

FLD-1.A

Calculate the magnitude of the gravitational force between two large spherically symmetrical masses.

FLD-1.B

Calculate the value for g or gravitational acceleration on the surface of the Earth (or some other large planetary object) and at other points outside of the Earth.

ESSENTIAL KNOWLEDGE

FLD-1.A.1

The magnitude of the gravitational force between two masses can be determined by using Newton's universal law of gravitation.

$$|\vec{F}_G| = \frac{Gm_1m_2}{r^2}$$

FLD-1.B.1

Using Newton's laws it can be shown that the value for gravitational acceleration at the surface of the Earth is:

$$g = \frac{GM_e}{R_e^2}$$

and if the point of interest is located far from the earth's surface, then g becomes:

$$g = \frac{GM_e}{r^2}$$

continued on next page

LEARNING OBJECTIVE

FLD-1.C

Describe the motion in a qualitative way of an object under the influence of a variable gravitational force, such as in the case where an object falls toward the Earth's surface when dropped from distances much larger than the Earth's radius.

ESSENTIAL KNOWLEDGE

FLD-1.C.1

The gravitational force is proportional to the inverse of distance squared; therefore, the acceleration of an object under the influence of this type of force will be nonuniform.

SUGGESTED SKILLS

 *Representing Data and Phenomena*

3.C Sketch a graph that shows a functional relationship between two quantities.

 *Theoretical Relationships*

5.D Determine or estimate the change in a quantity using a mathematical relationship.

 *Mathematical Routines*

6.C Calculate an unknown quantity with units from known quantities by selecting and following a logical computational pathway.

 *Argumentation*

7.F Explain how potential sources of experimental error may affect results and/or conclusions.



AVAILABLE RESOURCES

Classroom Resources >

- [AP Physics Featured Question: Projectile Concepts](#)
- [AP Physics Featured Question: Raft with Hanging Weights](#)
- [Critical Thinking Questions in Physics](#)
- [Physics Instruction Using Video Analysis Technology](#)
- [Quantitative Skills in the AP Sciences](#)
- [Teaching Strategies for Limited Class Time](#)

TOPIC 7.2

Orbits of Planets and Satellites

Required Course Content

ENDURING UNDERSTANDING

CON-6

Angular momentum and total mechanical energy will not change for a satellite in an orbit.

LEARNING OBJECTIVE

CON-6.A

Calculate quantitative properties (such as period, speed, radius of orbit) of a satellite in circular orbit around a planetary object.

CON-6.B

Derive Kepler's third law for the case of circular orbits.

ESSENTIAL KNOWLEDGE

CON-6.A.1

The centripetal force acting on a satellite is provided by the gravitational force between satellite and planet.

- a. The velocity of a satellite in circular orbit is inversely proportional to the square root of the radius and is independent of the satellite's mass.

CON-6.B.1

In a circular orbit, Newton's second law analysis can be applied to the satellite to determine the orbital velocity relationship for satellite of mass m about a central body of mass M .

- a. With proper substitutions, this can be reduced to expressing the period's dependence on orbital distance as Kepler's third law shows:

$$T^2 = \frac{4\pi^2}{GM} r^3$$

continued on next page

LEARNING OBJECTIVE

CON-6.C

Describe a linear relationship to verify Kepler’s third law.

CON-6.D

Calculate the gravitational potential energy and the kinetic energy of a satellite/Earth system in which the satellite is in circular orbit around the earth.

CON-6.E

Derive the relationship of total mechanical energy of a satellite/earth system as a function of radial position.

CON-6.F

- a. Derive an expression for the escape speed of a satellite using energy principles.
- b. Describe the motion of a satellite launched straight up (or propelled toward the planet) from the planet’s surface, using energy principles.

ESSENTIAL KNOWLEDGE

CON-6.C.1

Verifying Kepler’s third law with actual data provides experimental verification of the law.

CON-6.D.1

The gravitational potential energy of a satellite/Earth system (or other planetary/satellite system) in orbit is defined by the potential energy function of the system:

$$U_g = -\frac{Gm_em_{sat}}{r}$$

- a. The kinetic energy of a satellite in circular orbit can be reduced to an expression that is only dependent on the satellite’s system and position.

CON-6.E.1

The total mechanical energy of a satellite is inversely proportional to the orbital distance and is always a negative value and equal to one half of the gravitational potential energy.

CON-6.F.1

In ideal situations, the energy in a planet/satellite system is a constant.

- a. The gravitational potential energy of a planet/satellite system is defined to have a zero value when the satellite is at an infinite distance (very large planetary distance) away from the planet.
- b. By definition, the “escape speed” is the minimum speed required to escape the gravitational field of the planet. This could occur at a minimum when the satellite reaches a nominal speed of approximately zero at some very large distance away from the planet.

continued on next page

LEARNING OBJECTIVE**CON-6.G**

Calculate positions, speeds, or energies of a satellite launched straight up from the planet's surface, or a satellite that is projected straight toward the planet's surface, using energy principles.

CON-6.H

Describe elliptical satellite orbits using Kepler's three laws of planetary motion.

CON-6.I

- Calculate the orbital distances and velocities of a satellite in elliptical orbit using the conservation of angular momentum.
- Calculate the speeds of a satellite in elliptical orbit at the two extremes of the elliptical orbit (perihelion and aphelion).

ESSENTIAL KNOWLEDGE**CON-6.G.1**

In ideal nonorbiting cases, a satellite's physical characteristics of motion can be determined using the conservation of energy.

CON-6.H.1

The derivation of Kepler's third law is only required for a satellite in a circular orbit.

CON-6.I.1

In all cases of orbiting satellites, the total angular momentum of the satellite is a constant.

- The conservation of mechanical energy and the conservation of angular momentum can both be used to determine speeds at different positions in the elliptical orbit.

AP PHYSICS C: MECHANICS

Laboratory Investigations

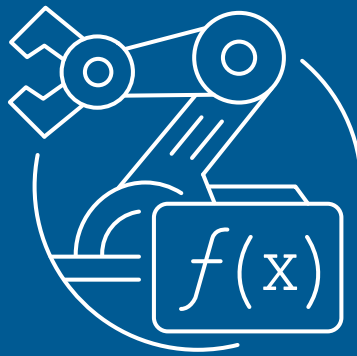

Lab Experiments

Although laboratory work has often been separated from classroom work, research shows that experience and experiment are often more instructionally effective when flexibly integrated into the development of concepts. When students build their own conceptual understanding of the principles of physics, their familiarity with the concrete evidence for their ideas leads to deeper understanding and gives them a sense of ownership of the knowledge they have constructed.

Scientific inquiry experiences in AP Physics C: Mechanics should be designed and implemented with increasing student involvement to help enhance inquiry learning and the development of critical thinking and problem-solving skills and abilities. Typically, the level of investigations in an AP Physics C: Mechanics classroom should focus primarily on the continuum between guided and open inquiry. However, depending on students' familiarity with a topic, a given laboratory experience might incorporate a sequence involving all four levels of inquiry (confirmation, structured inquiry, guided inquiry, and open inquiry).

Lab Manuals and Lab Notebooks

College Board publishes *AP Physics 1 and 2 Inquiry-Based Lab Investigations: A Teacher's Manual* to support the guided inquiry lab requirement for the course. It includes labs that teachers can choose from to satisfy the guided inquiry lab component for the course. Many publishers and science classroom material distributors offer affordable lab manuals with outlined experiments and activities as well as lab notebooks for recording lab data and observations. Students can use any type of notebook to fulfill the lab notebook requirement, even an online document. Consider the needs of the classroom when deciding what type of lab notebook to use.

Lab Materials

A wide range of equipment may be used in the physics laboratory, from generic lab items, such as metersticks, rubber balls, springs, string, metal spheres, calibrated mass sets, beakers, glass and cardboard tubes, electronic balances, stopwatches, clamps, and ring stands, to items more specific to physics, such as tracks, carts, light bulbs, resistors, magnets, and batteries. Successful guided inquiry student work can

be accomplished with simple, inexpensive materials and with more sophisticated physics equipment, such as air tracks, force sensors, and oscilloscopes. Remember that the AP lab should provide experience for students equivalent to that of a college laboratory, so teachers are encouraged to make every effort to provide a range of experiences—from experiments students contrive from plumbing pipe, string, and duct tape to experiments in which students gather and analyze data using calculators or computer-interfaced equipment.

There are avenues that teachers can explore as a means of getting access to more expensive equipment, such as computers and probes. Probes can often be rented for short periods of time from instrument suppliers. Alternatively, local colleges or universities may allow high school students to complete a lab as a field trip on their campus, or they may allow teachers to borrow their equipment. They may even donate their old equipment. Some schools have partnerships with local businesses that can help with laboratory equipment and materials. Teachers can also utilize online donation sites such as Donors Choose and Adopt-A-Classroom.

Lab Time

For AP Physics C: Mechanics to be comparable to a college physics course, it is critical that teachers make laboratory work an important part of their curriculum. An analysis of data from AP Physics examinees, regarding the length of time they spent per week in the laboratory, shows that increased laboratory time correlates with higher AP scores. Flexible or modular scheduling must be implemented to meet the time requirements identified in the course outline. At minimum, one double period a week is needed. Furthermore, it is important that the AP Physics laboratory program be adapted to local conditions and funding as it aims to offer the students a well-rounded experience with experimental physics. Adequate laboratory facilities should be provided so that each student has a work space where equipment and materials can be left overnight if necessary. Sufficient laboratory equipment for the anticipated enrollment and appropriate instruments should be provided. Students in AP Physics should have access to computers with software appropriate for processing laboratory data and writing reports.

How to Set Up a Lab Program

Physics is not just a subject. Rather, it is a way of approaching scientific discovery that requires personal observation and physical experimentation. Being successful in this endeavor requires students to synthesize and use a broad spectrum of knowledge and skills, including mathematical, computational, experimental, and practical skills, and to develop habits of mind that might be characterized as thinking like a physicist. Student-directed, inquiry-based lab experience supports the AP Physics C: Mechanics course and AP Course Audit curricular requirements. It provides opportunities for students to design experiments, collect data, apply mathematical routines and methods, and refine testable explanations and predictions. The AP Physics C: Mechanics course should include a hands-on laboratory component comparable to a semester-long introductory college-level physics laboratory. Students should spend a minimum of 25% of instructional time engaged in hands-on laboratory work.

The AP Physics C: Mechanics Exam directly assesses the learning objectives of the course framework, which means that the inclusion of appropriate experiments aligned with those learning objectives is important for student success. Teachers should select experiments that provide students with the broadest laboratory experience possible.

We encourage teachers to be creative in designing their lab program while ensuring that students explore and develop understandings of these core techniques. After completion, students should be able to describe how to construct knowledge, model (create an abstract representation of a real system), design experiments, analyze visual data, and communicate physics. Students should also develop an understanding of how changes in the design of the experiments would affect the outcome of their results. Many questions on the AP Exam are written in an experimental context, so these skills will prove invaluable for both concept comprehension and exam performance.

Because AP Physics C: Mechanics is equivalent to a college course, the equipment and time allotted

to laboratories should be similar to that in a college course. Therefore, school administrators should realize the implications, in both cost and time, of incorporating serious laboratories into their program. Schools must ensure that students have access to scientific equipment and all materials necessary to conduct hands-on, college-level physics laboratory investigations.

Getting Students Started

There are no prescriptive “steps” to the iterative process of inquiry-based investigations. However, there are some common characteristics of inquiry that will support students in designing their investigations. Often, this simply begins with using the learning objectives to craft a question for students to investigate. Teachers may choose to give students a list of materials they are allowed to use in their design or require that students request the equipment they feel they need to investigate the question. Working with learning objectives to craft questions may include the following:

- Selecting learning objectives from the course framework that relate to the subject under study, and that may set forth specific tasks, in the form of “Design an experiment to”
- Rephrasing or refining the learning objectives that align to the unit of study to create an inquiry-based investigation for students.

Students should be given latitude to make design modifications or ask for additional equipment appropriate for their design. It is also helpful for individual groups to report to the class their basic design to elicit feedback on feasibility. Guided student groups can proceed through the experiment, with the teacher allowing them the freedom to make mistakes—as long as those mistakes don’t endanger students or equipment or lead the groups too far off task. Students should have many opportunities for post-lab reporting so that groups can understand the successes and challenges of individual lab designs.

Communication, Group Collaboration, and the Laboratory Record

Laboratory work is an excellent means through which students can develop and practice communication skills. Success in subsequent work in physics depends heavily on an ability to communicate about observations, ideas, and conclusions. Students must learn to recognize that an understanding of physics is relatively useless unless they can communicate their knowledge effectively to others. By working together in a truly collaborative manner to plan and carry out experiments, students learn oral communication skills and teamwork. Students must be encouraged to take full individual responsibility for the success, or failure, of the collaboration.

After students are given a question for investigation, they may present their findings in either a written or an oral report to the teacher and class for feedback and critique on their final design and results. Students should be encouraged to critique and challenge one another's claims based on the evidence collected during the investigation.

Laboratory Safety

Giving students the responsibility for design of their own laboratory experience involves special responsibilities for teachers. To ensure a safe working environment, teachers should first provide the limitations and safety precautions necessary for potential procedures and equipment students may use during their investigation. Teachers should also

provide specific guidelines prior to students' discussion on investigation designs for each experiment, so that those precautions can be incorporated into final student-selected lab designs and included in the background or design plan in a laboratory record. It may also be helpful to print the precautions that apply to that specific lab as safety notes to place on the desk or wall near student workstations. Additionally, a general set of safety guidelines should be set forth for students at the beginning of the course. The following is a list of possible general guidelines teachers may post.

- Before each lab, make sure you know and record the potential hazards involved in the investigation, as well as the precautions you will take to stay safe.
- Before using equipment, make sure you know the proper method of use to acquire good data and avoid damage to equipment.
- Know where safety equipment is located in the lab, such as the fire extinguisher, safety goggles, and the first aid kit.
- Follow the teacher's special safety guidelines as set forth prior to each experiment. (Students should record these as part of their design plan for a lab.)
- When in doubt about the safety or advisability of a procedure, check with the teacher before proceeding.

Teachers should interact constantly with students as they work to observe safety practices and anticipate and discuss with them any problems that may arise. Walking among student groups, asking questions, and showing interest in students' work allow teachers to keep the pulse of what students are doing and maintain a watchful eye for potential safety issues.

THIS PAGE IS INTENTIONALLY LEFT BLANK.

AP PHYSICS C: MECHANICS

Instructional Approaches

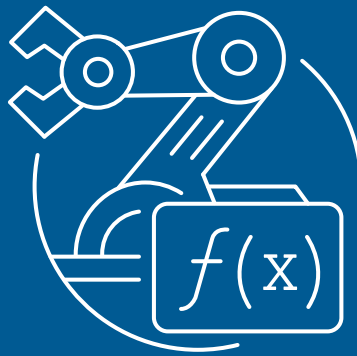

Selecting and Using Course Materials

Teachers will benefit from a wide array of materials to help students become proficient with the science practices and skills necessary to develop a conceptual understanding of the relationships, laws, and phenomena studied in AP Physics C: Mechanics. In addition to using a college-level textbook that will provide required course content, students should have regular opportunities to create and use data, representations, and models. Rich, experimental investigation is the cornerstone of AP Physics, and diverse source material allows teachers more flexibility in designing the types of learning activities that will help develop the habits of thinking like a physicist.

Textbooks

While nearly all college-level physics textbooks address the seven units of AP Physics C: Mechanics, it's important for teachers to identify other types of secondary sources to supplement the chosen textbook accordingly, ensuring that each of the seven topic areas and, as well as the science practices, receive adequate attention.

AP Central provides an [example textbook list](#) to help determine whether a text is considered appropriate in meeting the AP Physics C: Mechanics Course Audit resource requirement. Teachers can also select textbooks locally.

Guided Inquiry in AP Physics C: Mechanics

AP Physics courses require students to engage with data in a variety of ways. The analysis, interpretation, and application of quantitative information are vital skills for students in AP Physics C: Mechanics. Scientific inquiry experiences in this course should be designed and implemented with increasing student involvement to help enhance inquiry learning and the development of critical thinking and problem-solving

skills and abilities. Typically, the level of investigations in an AP Physics C: Mechanics classroom should focus primarily on the continuum between guided and open inquiry. However, depending on students' familiarity with a topic, a given laboratory experience might incorporate a sequence involving all four levels of inquiry (confirmation, structured inquiry, guided inquiry, and open inquiry).

Instructional Strategies

The AP Physics C: Mechanics course framework outlines the concepts and skills students must master in order to be successful on the AP Exam. In order to address those concepts and skills effectively, teachers should incorporate a variety of instructional approaches and best practices into their daily lessons and activities. Teachers can help students develop mastery of the skills by engaging them in learning activities that allow them to apply their understanding of course concepts. Teachers may consider the following strategies as they plan instruction. Please note they are listed alphabetically and not by order of importance or instruction.

Strategy	Definition	Purpose	Example
<i>Ask the Expert</i>	Students are assigned as “experts” on problems they have mastered. Groups rotate through the expert stations to learn about problems they have not yet mastered.	Students to share their knowledge and learn from one another.	In rotational mechanics, assign students as “experts” on rotation questions involving different solution techniques. Have students move through stations in groups, working with the station expert to justify a set of claims with corresponding physical laws.
<i>Bar Chart</i>	Bar chart tasks have histograms for one or more quantities. Frequently, histograms are given for before and after some physical process with one bar left off. Students are asked to complete the bar chart by supplying the value for the missing quantity. These are a new type of representation, requiring the students to translate between whatever other representation they are using and this one. Bar chart tasks are usually quite productive in helping students to make meaning. These items can be especially useful since most students seem to adapt to bar chart representations relatively easily.	Bar chart tasks help students make meaning by asking them to translate between before and after some physical process.	This strategy can be used with conservation laws. Ask students to define the system and then create bar charts for before and after some event. For example, students might create an energy bar chart for a ball rolling down an incline. Students would identify the system and then create one set of charts for the top of the incline and a separate set of charts for the bottom of the incline.

continued on next page

Strategy	Definition	Purpose	Example
<i>Changing Representations</i>	These tasks require students to translate from one representation (e.g., an electric field diagram) to another (e.g., an equipotential curves or surfaces diagram). Students often learn how to cope with one representation without really learning the role and value of representations and their relationship to problem solving. Getting them to go back and forth between/among different representations for a concept helps them develop a more robust understanding of each representation. Among the representations that will be employed are mathematical relationships, so this task can serve, at times, as a bridge between conceptual understanding and traditional problem solving.	Students create pictures, tables, graphs, lists, equations, models, and/or verbal expressions to interpret text or data. This helps organize information using multiple ways to present data and answer a question or show a problem's solution.	As students learn about energy conservation, ask them to move between different representations. For example, for a given situation involving energy conservation, students should be able to create a sketch of the identified system, a set of conservation of energy equations, sets of energy bar charts and graphs of potential energy, kinetic energy, total energy, or combinations of the above representations.
<i>Concept-Oriented Demonstration</i>	These tasks involve an actual demonstration but with the students doing as much of the description, prediction, and explanation as possible. Although the demonstration should produce results students don't expect, students should nonetheless feel comfortable making predictions about what will happen.	Involving an actual demonstration, students are asked to predict and explain.	This strategy is useful for helping students to practice writing descriptions, predictions, and explanations. Often when conducting an experiment, data collection takes the most amount of time and gets the most amount of focus, so students mistakenly believe it to be the most important piece. If teachers supplement their longer laboratory experiments with concept-oriented demonstrations, students can practice important laboratory skills (description, prediction, and explanation) without taking huge amounts of class time collecting data.

continued on next page

Strategy	Definition	Purpose	Example
<i>Conflicting Contentions</i>	Conflicting contentions tasks present students with two or three statements that disagree in some way, and students decide which contention they agree with and explain why. These tasks are very useful for contrasting statements of students' alternate conceptions with physically accepted statements. This process is facilitated in these tasks because they can be phrased as "which statement do you agree with and why" rather than asking which statement is correct or true. These tasks complement the "What if Anything Is Wrong?" tasks.	These tasks help contrast statements of students' alternate conceptions with physically accepted statements.	This strategy is useful for helping students begin to understand how to write a full argument. By providing the arguments and having students identify good claims (and not-so-good claims) and good evidence and reasoning (and not-so-good evidence and reasoning), teachers can help scaffold the practice of good argumentation for their students.
<i>Construct an Argument</i>	Students use mathematical reasoning to present assumptions about mathematical situations, support conjectures with mathematically relevant and accurate data, and provide a logical progression of ideals leading to a conclusion that makes sense.	Helps develop reasoning skills and enhances communication skills in supporting conjectures and conclusions. This strategy also helps develop the process of evaluating mathematical information.	This strategy can be used with word problems that do not lend themselves to immediate application of a formula or mathematical process. The teacher can provide distance and velocity graphs that represent a motorist's behavior through several towns on a map and ask students to construct a mathematical argument either in defense of or against a police officer's charge of speeding, given a known speed limit.
<i>Create a Plan</i>	Students analyze the tasks in a problem and create a process for completing the tasks by finding the information needed, interpreting data, choosing how to solve a problem, communicating the results, and verifying accuracy.	Assists in breaking tasks into smaller parts and identifying the steps needed to complete the entire task.	When scaffolding for students how to design an experiment, a good first step is assigning small groups to analyze the tasks necessary to design the experiment. Have students identify the steps needed to answer the question by collecting and analyzing data. Included in this discussion is a plan for what to do with the collected data.

continued on next page

Strategy	Definition	Purpose	Example
<i>Debriefing</i>	Students discuss the understanding of a concept to lead to a consensus on its meaning.	Helps clarify misconceptions and deepen understanding of context.	To discern the difference between average velocity and instantaneous velocity, have students roll a ball down a simple ramp and measure the distance the ball travels over time, every second for 5 seconds. Plotting position versus time and sketching a curve of best fit, have students discuss how they might determine the average velocity of the ball over the 5 seconds and then the instantaneous velocity of the ball at several points. A discussion in which students address the distinction between the ball's velocity between two points and its velocity at a single point would help in clarifying the concept and mathematical process.
<i>Desktop Experiment Tasks</i>	These tasks involve students performing a demonstration at their desks (either in class or at home), using a predict-and-explain format. After students complete the experiment, have them "reformulate" or reconsider their previous explanations in light of what happened. Desktop experiment tasks are narrow in scope, usually qualitative in nature, and typically use simple equipment.	Students are presented with a small desktop experiment and asked to use the apparatus provided to answer a given question.	Direct measurement videos make excellent "desktop" experiments that students can work with either in class or for homework. Desktop experiment tasks can include small experiments using toy cars or spring scales, for example.
<i>Discussion Groups</i>	Students work in groups to discuss content, create problem solutions, and explain and justify a solution.	Aids in understanding through the sharing of ideas, interpretation of concepts, and analysis of problem scenarios.	Once students learn all methods of problem solving and can select which is the most appropriate given a particular situation, have them discuss in small groups (no writing) why a specific method should be used over another.

continued on next page

Strategy	Definition	Purpose	Example
<i>Friends Without Pens</i>	Students are given a free-response question, quiz, or challenging problem. “Friends without pens” takes place in two rounds: the first round is the timed “friends without pens” round, in which students are grouped together and can discuss—but not write about—the question. At the end of the time, students return to their desks for the “pens without friends” round, where they tackle the assignment in the traditional, independent sense.	This can be a scaffolding tool, if students are being introduced to a new type of assignment or a particularly difficult or challenging AP-level question.	Students identify and discuss, with their peers, adequate claims, evidence, and reasoning. They then return to their desks to create the full argument.
<i>Four-Square Problem Solving</i>	Students are given a situation, perhaps one that came from a traditional, plug-and-chug problem. They then divide a sheet of paper into four quadrants. In each quadrant, the student(s) put some representation of what is going on in the problem. Possible representations include motion maps or graphs, free-body diagrams, energy bar graphs, momentum bar graphs, mathematical models (equation with symbols), well-labeled diagrams, or written responses (2–3 strong, clear sentences).	Re-expressing or re-representing data is a key skill necessary for student success in this course. Multiple opportunities with this task scaffolds the needed practice for students to get into the habit of creating and using representations to make claims and answer questions.	In Unit 3, students can regularly and repeatedly do four-square problem solving with work and energy questions. They can sketch graphs or free-body diagrams, write paragraphs, and solve numerical and/or symbolic problems.
<i>Graph and Switch</i>	Students generate a graph (or sketch of a graph) to model a certain function, and then switch calculators (or papers) to review each other’s solutions.	Allows students to practice creating different representations of functions as well as both giving and receiving feedback on each other’s work.	As students learn about graphs of potential energy, they can graph potential energy versus position and force versus position. Have students individually graph and explain how their graphs support claims and are consistent with each other. They then share their steps with a partner and receive feedback on their graphs, claims, evidence, and reasoning.
<i>Graphic Organizer</i>	Students arrange information into charts and diagrams.	Builds comprehension and facilitates discussion by representing information in visual form.	In order to organize the position, velocity, and acceleration versus time graphs for an object under the influence of a resistive force, students can create a table to help them keep track of their logic as they think through the different functional relationships that are seen in these graphs.

continued on next page

Strategy	Definition	Purpose	Example
Identify Subtasks	Students break a problem into smaller pieces with outcomes leading to a solution.	Helps organize the pieces of a complex problem and reach a complete solution.	Another scaffolding technique: when first exposing students to AP-level questions that involve several steps of reasoning and logic, additional questions can be added to help guide students to the final claim, evidence, and reasoning. For example, ask students to sketch a free-body diagram, discuss the system, and/or draw energy bar charts. After the first few units, students should be able to identify (first in groups and then individually) what the subtasks would be (free-body diagram), to start thinking about the claim, evidence, and reasoning.
Marking the Text	Students highlight, underline, and/or annotate text to focus on key information to help understand the text or solve the problem.	Helps the student identify important information in the text and make notes in the text about the interpretation of tasks required and concepts to apply to reach a solution.	This strategy can be used with AP-level problems as well as problems from the text or sample laboratory procedures. Students read through the question, experimental design (or another student's experimental design) and underline the pronouns, equipment, key information, (i.e., the car begins at rest) etc. to identify important information and to be able to ask clarifying questions.
Meaningful, Meaningless Calculations	Students are presented with an unreduced expression for a calculation for a physical quantity describing a physical situation. They must decide whether the calculation is meaningful (i.e., it gives a value that tells us something legitimate about the physical situation) or is meaningless (i.e., the expression is a totally inappropriate use of a relation). These calculations should not be trivially meaningless, such as substituting a wrong numerical value into the expression. These items are best when the quantity calculated fits with students' alternative conceptions.	Students are presented with an unreduced calculation for a physical calculation that involves a mathematical relationship, and students are asked if the calculation makes any sense.	These calculations can take many forms, but the most useful are those where the "meaningless" calculations illustrate common student misconceptions. Students could be asked to write an expression for the energy of a system. Students then have to decide which of the following expressions are meaningful (MgD, Mg/D, MD/g, and 1/MgD).

continued on next page

Strategy	Definition	Purpose	Example
Model Questions	Students answer items from released AP Physics Exams.	Provides challenging practice and assesses students' ability to apply multiple physical practices on content as either a multiple-choice or a free-response question.	Model questions can be AP-released questions or AP-level questions. They can be given as written, or scaffolded for students earlier in the year to provide them with support.
Note Taking	Students create a record of information while reading a text or listening to a speaker.	Helps organize ideas and process information.	Have students can write down verbal descriptions of the steps needed to solve a problem so that a record of the processes can be referred to at a later point in time.
Predict and Explain	Predict and explain tasks describe a physical situation that is set up at a point where some event is about to occur. Students predict and explain what they think will happen. These tasks must involve situations with which the students are familiar, or have sufficient background information in, to enable them to understand the task. This is important, because otherwise students usually do not feel comfortable enough to attempt to answer.	Stimulates thinking by asking students to make, check, and correct predictions based on evidence from the outcome.	When an object on the end of a string is set into SHM, ask students what would happen to the period if the mass were increased, the angle were decreased, or the length of the string changed?
Qualitative Reasoning	These tasks can take a variety of forms, with their common denominator being qualitative analysis. Frequently, students are presented with an initial and final situation and asked how some quantity, or aspect, will change. Qualitative comparisons (e.g., the quantity increases, decreases, or stays the same) are often the appropriate answer. Qualitative reasoning tasks can frequently contain elements found in some of the other task formats (e.g., different qualitative representations and a prediction or explanation).	Students are presented with a physical situation and asked to apply a principle to qualitatively reason out what will happen. These questions are commonly found in other multiple-choice question subtypes.	Ask students what would happen to the angular momentum of an object in orbit around the Earth if the radius of orbit were increased, if the speed of orbit were decreased, or if the mass of the Earth or the mass of the object were changed. Additional questions could include, "What happens to the energy of the system as the physical properties above are changed?"

continued on next page

Strategy	Definition	Purpose	Example
<i>Quickwrite</i>	Students write for a short, specific amount of time about a designated topic.	Helps generate ideas in a short amount of time.	To help synthesize concepts after having learned how to calculate the derivative, have students list as many real-world situations as possible in which knowing the instantaneous rate of change of a function is advantageous.
<i>Ranking</i>	Ranking tasks present students with a set of variations—sometimes three or four but usually six to eight—on a basic physical situation. The variations differ in value (numeric or symbolic) for the variables involved but also frequently include variables that are not important to the task. The students' objective is to rank the variations on the basis of a specified physical quantity. Students must also explain the reasoning for their ranking scheme and rate their confidence in their ranking.	These tasks require students to engage in a comparison reasoning process that they seldom have opportunities to do in traditional problem solving.	Given six different arrows launched from the ground with different speeds at different angles, ask students to rank the arrows on the basis of the highest acceleration at the top, the longest time in the air, and the largest velocity at the top.
<i>Sharing and Responding</i>	Students communicate with another person or a small group of peers who respond to a proposed problem solution.	Gives students the opportunity to discuss their work with peers, make suggestions for improvement to the work of others, and/or receive appropriate and relevant feedback on their own work.	Group students to review individual work (graphs, derivations, problem solutions, experimental designs, etc.). Have the groups make any necessary corrections and build a single complete solution together.
<i>Simplify the Problem</i>	Students use friendlier numbers or functions to help solve a problem.	Provides insight into the problem or the strategies needed to solve the problem.	Have students use the analogy of one-dimensional motion when initially analyzing rotational kinematics.
<i>Troubleshooting</i>	Troubleshooting tasks are variations on the "What if Anything Is Wrong?" task. Students are explicitly told that there is an error in the given situation. Their job is to determine what the error is and explain how to correct it. These tasks can often produce interesting insights into students' thinking because they will, at times, identify some correct aspect of the situation as erroneous. This helps develop additional items.	Allows students to troubleshoot errors and misconceptions by focusing on problems that may arise when they do the same procedures themselves.	Give students a derivation or problem solution and ask them to find the incorrect step(s). Students must not only identify, but also explain the mistake or misunderstanding that led to the mistake. This can also be done with bar charts, diagrams, and other representations.

continued on next page

Strategy	Definition	Purpose	Example
<i>“What if Anything Is Wrong?”</i>	Requires students to analyze a statement or diagrammed situation to determine if it is correct or not. If everything is correct, the student is asked to explain the statement/ situation and why it works as described. If something is incorrect, the student has to identify the error and explain how to correct it. These are open-ended exercises, so they provide insight into students’ ideas, since they will often have interesting reasons for accepting incorrect situations and for rejecting legitimate situations. Often, students’ responses provide ideas for other items.	Allows students to troubleshoot errors and focus on problems that may arise when they do the same procedures themselves.	Give students a force diagram that may or may not have incorrect forces drawn on it. Or, give them graphs of force and potential energy that “match” and ask them to determine if the graphs do indeed correspond. This technique can also be used in derivations and problem solving where students are given the “complete” solution and are asked to verify whether it was done correctly.
<i>Write and Switch</i>	Like graph and switch but with writing. Students make observations, collect data, or make a claim and then switch papers.	Allows students to practice writing as well as both giving and receiving feedback on each other’s work.	As students learn about creating an argument, they can draft an initial argument themselves; share their claim, evidence, and reasoning with a partner; and receive feedback on their argument.
<i>Working Backward</i>	This task reverses the order of the problem steps. For example, the given information could be an equation with specific values for all, or all but one, of the variables. The students must then construct a physical situation for which the given equation would apply. Such working backward tasks require students to take numerical values, including units, and translate them into physical variables. Working backward problems also require students to reason about these situations in an unusual way, and they often allow for more than one solution.	Provides another way to check possible answers for accuracy.	Students are given an equation such as $4m = 6\frac{m}{s} - 9\frac{m}{s^2}$ and students are asked to create another representation from this equation. For example, a written scenario that this equation could represent may include position versus time graphs, velocity versus time graphs, motion maps, etc.

Developing the Science Practices

Throughout the course, students will develop skills that are fundamental to the discipline of physics. Since these practices represent the complex skills that adept physicists demonstrate, students will benefit from multiple opportunities to develop them in a scaffolded manner. Through the use of guided questioning, discussion techniques, and other instructional strategies, teachers can help their students practice applying these skills in new contexts, providing an important foundation for their college and career readiness.

Science Practice 1: Visual Representations

Analyze and/or use [non-narrative/non-mathematical] representations of physical situations, excluding graphs.

The real world is extremely complex. When physicists describe and explain phenomena, they try to simplify real objects, systems, and processes to make the analysis manageable. These simplifications, or models, are used to predict how new phenomena will occur. A simple model may treat a system as an object, neglecting the system's internal structure and behavior. More complex models are models of a system of objects, such as an ideal gas. A process can be simplified, too, and models can be both conceptual and mathematical. To make a good model, one needs to identify a set of the most important characteristics of a phenomenon or system that may simplify analysis. Inherent in the construction of models that physicists invent is the use of representations. Examples of representations used to model introductory physics are pictures, free-body diagrams, force diagrams, graphs, energy bar charts, and momentum bar charts. Representations help in analyzing phenomena, making predictions, and communicating ideas. AP Physics C: Mechanics requires students to use and/or analyze and/or re-express models and representations of natural or man-made systems.

The following table provides examples of questions and instructional strategies for implementing visual representations and modeling resources into the course:

Skills	Key Questions	Instructional Notes or Sample Activities	Instructional Strategies
1.A Describe the physical meaning (includes identifying features) of a representation.	<ul style="list-style-type: none"> What does the representation show? 	Have students describe the physical features and meaning of figures and representations including figures and representations from the textbook and other reference sources.	<ul style="list-style-type: none"> Label and Describe "What if Anything Is Wrong?" Graph and Switch Discussion Groups
1.B Describe the relationships between different types of representations of the same physical situation.	<ul style="list-style-type: none"> What is the relationship between the representations? What is the relationship between the variables represented? 	Have students match representations that are of the same physical situation, and explain what characteristics help them recognize that the representations are of the same situation.	<ul style="list-style-type: none"> "What if Anything Is Wrong?" Changing Representations

continued on next page

Skills	Key Questions	Instructional Notes or Sample Activities	Instructional Strategies
1.C <i>Demonstrate consistency between different types of representations of the same physical situation.</i>	<ul style="list-style-type: none"> What characteristic or physical quantity of the situation does each representation illustrate? How do the representations show consistency? 	Have students divide their paper into four quarters and provide four different representations for a given physical situation. Representations can include an equation, a written sentence (or paragraph), a graph, a bar chart, or a sketch of the physical scenario.	<ul style="list-style-type: none"> “What if Anything Is Wrong?” Changing Representations Four-Square Problem Solving
1.D <i>Select relevant features of representations to answer a question or solve a problem.</i>	<ul style="list-style-type: none"> What does the representation show? What features of the representation provide information relevant to the question or problem? 	Have students practice identifying relevant features of representations by having them identify features of representations without questions attached. AP Physics question prompts are good sources of practice representations.	<ul style="list-style-type: none"> “What if Anything Is Wrong?” Changing Representations Bar Chart
1.E <i>Describe the effects of modifying assumptions about a representation of a physical situation.</i>	<ul style="list-style-type: none"> What assumptions are being made in this physical situation? What changes would occur if these assumptions were altered (for example, how would a free-body diagram of an object in free fall change if air resistance was included in the analysis)? What assumptions are being made in the creation of the representation? If changes are made to the representation, how would that affect the physical situation? 	Have students practice modifying assumptions about every problem they do. During homework, class work, quizzes, and tests, ask students to explain how modifying assumptions about representations will alter the physical situation and how changing the physical situation will alter the representations.	<ul style="list-style-type: none"> Qualitative Reasoning Four-Square Problem Solving

Science Practice 2: Question and Method

Determine scientific questions and methods.

Scientific questions can range in scope, from broad to narrow, as well as in specificity and from determining influencing factors and/or causes to determining mechanism. The question posed will determine the type of data to be collected and will influence the plan for collecting data. Designing and improving experimental designs and/or data collection strategies is a learned skill. Class discussion can reveal issues of measurement uncertainty and assumptions in the data collection. Students need to understand that the results of collecting and using data to determine a numerical answer to a question is best thought of as an interval, not a single number. This interval, the experimental uncertainty, is due to a combination of uncertainty in the instruments used and the process of taking the measurement. Although detailed error analysis is not necessary to convey this pivotal idea, it is important that students make some reasoned estimate of the interval within which they know the value of a measured data point and express their results in a way that makes this clear.

Laboratory experience is also important in helping students understand the topics being considered. Thus, it is valuable to ask students to write informally about what they have done, observed, and concluded in well-organized laboratory notebooks. Some questions or parts of questions on the AP Physics C: Mechanics Exam deal with lab-related skills, such as the design of experiments, data analysis, and error analysis, and are intended to distinguish between students who have had laboratory experience and those who have not. In addition, the understanding gained in the laboratory may improve a student's test performance overall.

Examples of scientific experiments include guided, inquiry-based, hands-on lab investigations; individual, hands-on lab investigations; lab demonstrations; or lab-based, hands-on classroom activities.

The following table provides examples of questions and instructional strategies for implementing question and method resources into the course:

Skills	Key Questions	Instructional Notes or Sample Activities	Instructional Strategies
2.A <i>Identify a testable scientific question or problem.</i>	<ul style="list-style-type: none"> What differentiates a testable or scientific question from a nonscientific question? 	Have students list questions about a topic, and then in groups have them choose and refine one of the questions into a scientifically testable question.	<ul style="list-style-type: none"> Discussion Groups Create a Plan
2.B <i>Make a claim or predict the results of an experiment.</i>	<ul style="list-style-type: none"> What hypotheses or predictions can be made about the physical situation? What types of evidence could be collected to defend the hypotheses or prediction? 	Have students list possible hypotheses and/or predictions and the necessary evidence to defend each.	<ul style="list-style-type: none"> Concept-Oriented Demonstration Predict and Explain
2.C <i>Identify appropriate experimental procedures (which may include a sketch of a lab setup).</i>	<ul style="list-style-type: none"> What information will be needed to answer the scientific question? What equipment is needed to collect the necessary data? How will each piece of equipment be used to collect the necessary data? What will be done with the data (data analysis) to answer the scientific question? 	<p>Have students practice designing plans for collecting data to answer scientific questions. Laboratory design procedures do not always have to be carried out.</p> <p>For example, have students design an experiment and analyze graphical data where the area under a curve is needed to determine the work done on or by the object or system.</p>	<ul style="list-style-type: none"> Create a Plan Troubleshooting Desktop Experiment

continued on next page

Skills	Key Questions	Instructional Notes or Sample Activities	Instructional Strategies
2.D <i>Make observations or collect data from representations of laboratory setups or results</i>	<ul style="list-style-type: none"> ▪ What observations can be recorded from the beginning/middle/end of the experiment? ▪ Are these qualitative or quantitative observations? If they are qualitative, is there a way to make them quantitative? ▪ What quantitative data can be collected from the laboratory setup or results? 	<p>Have students list the possible “human errors” to be aware of and how poor measurement techniques can affect collected observations and/or data. So-called human errors should be reduced as much as possible. Students should not refer to “human error” as the source of uncertainty in measurement.</p>	<ul style="list-style-type: none"> ▪ Write and Switch ▪ Desktop Experiment
2.E <i>Identify or describe potential sources or experimental error.</i>	<ul style="list-style-type: none"> ▪ What possible human errors need to be addressed before data collection? ▪ What inherent errors in data collection need to be addressed in the final result of the experiment? ▪ How do the inherent errors affect the final result of the experiment? 	<p>Have students list the common sources of uncertainty and error. Then, have them identify and/or describe the manner in which each source would affect the results of the experiment.</p>	<ul style="list-style-type: none"> ▪ Troubleshooting ▪ Desktop Experiment
2.F <i>Explain modifications to an experimental procedure that will alter results.</i>	<ul style="list-style-type: none"> ▪ What modifications could be accomplished for the physical situation? ▪ How will each modification alter the results of the experimental procedure? 	<p>Have students perform a write and switch to explain how modifications to an experimental procedure will alter results of the experiment. For example, ask them how changing to a more massive pulley will change the acceleration of an Atwood machine.</p>	<ul style="list-style-type: none"> ▪ Desktop Experiment ▪ Write and Switch ▪ Predict and Explain

Science Practice 3: Representing Data and Phenomena

Create visual representations or models of physical situations.

AP Physics C: Mechanics requires several key skills, including drawing and interpreting graphs and representing data or physical relationships in graphical form. Students need to be able to think about the material in their physics courses in terms of conceptual, verbal, graphical, and mathematical ideas. As part of these comprehensive skills for understanding the physical world around them, students must be able to perform graphical analysis in its many forms. With the use of graphing calculators, students appear to be losing the ability to draw, interpret, and understand graphs. There appears to be a disconnect between what students learn in their mathematics courses and how they apply that knowledge in their physics course. For example, even if students have learned graphing in previous math courses and understand the concept of slope, they may have difficulty understanding that the slope of a displacement-versus-time graph is the velocity. The AP Physics C: Mechanics course should provide opportunities to bridge the gap between physics and mathematics for students.

The following table provides examples of questions and instructional strategies for implementing data and phenomena representation resources into the course:

Skills	Key Questions	Instructional Notes or Sample Activities	Instructional Strategies
3.A <i>Select and plot appropriate data.</i>	<ul style="list-style-type: none"> What data should be plotted? What scale and axis labels should be used? 	Have students identify data that can be graphed in new situations without the help of understanding ahead of time the relationships between the quantities being investigated.	<ul style="list-style-type: none"> “What if Anything Is Wrong?” Graph and Switch Discussion Groups
3.B <i>Represent features of a model or the behavior of a physical system using appropriate graphing techniques, appropriate scale, and units.</i>	<ul style="list-style-type: none"> What important physical features can be represented by a graph? What quantities should be graphed in order to represent the model or system? What does an appropriately scaled graph look like? What does a graph need to contain to be called “correctly labeled”? 	Have students identify correct graphs by giving them a “What if Anything Is Wrong?” task. Present students with a set of data and a matching graph, and ask them to identify what, if anything, is wrong with the graph. The “wrong” things can be simple at first (scales not uniform, labels left off) and then later in the course can be scaffolded to be more difficult and address student misconceptions.	<ul style="list-style-type: none"> “What if Anything Is Wrong?” Graph and Switch Changing Representations
3.C <i>Sketch a graph that shows a functional relationship between two quantities.</i>	<ul style="list-style-type: none"> What are the main functional relationships needed to represent phenomena? What is the relationship between the two physical quantities? 	Have students sketch a graph that shows a functional relationship between two quantities and then switch with a partner. Students both give and receive feedback on each other’s work.	<ul style="list-style-type: none"> Graph and Switch Troubleshooting Identify Subtasks
3.D <i>Create appropriate diagrams to represent physical situations.</i>	<ul style="list-style-type: none"> What types of diagrams can be used to represent different kinds of physical situations? How many different kinds of representations can be used for a physical scenario? 	Have students practice creating appropriate diagrams by giving them working backward tasks. Give students a full problem solution and ask them to create appropriate diagrams (for example, force diagrams or free-body diagrams) that match the problem solution.	<ul style="list-style-type: none"> Working Backward Graph and Switch

Science Practice 4: Data Analysis

Analyze quantitative data represented in graphs.

Students often think that to make a graph they need to connect the data points or that the best-fit function is always linear. Thus, it is important that they can construct a best-fit curve even for data that do not fit a linear relationship. Students should be able to represent data points as intervals whose size depends on the experimental uncertainty. After students find a pattern in the data, they need to ask why this pattern is present and try to explain it using the knowledge that they have. When dealing with a new phenomenon, they should be able to devise a testable explanation of the pattern if possible. It is important that students understand that instruments do not produce exact measurements and learn what steps they can take to decrease the uncertainty.

Students should be able to design a second experiment to determine the same quantity and then check for consistency across the two measurements, comparing two results by writing them both as intervals and not as single, absolute numbers. Finally, students should be able to revise their reasoning based on the new data, data for some that may appear anomalous. The analysis, interpretation, and application of quantitative information are vital skills for students in AP Physics C: Mechanics. Analysis skills can be taught using any type of data, but students will be more invested in the data analysis if it is data they have collected through their own investigations. Teachers are encouraged to provide opportunities for students to analyze data, draw conclusions, and apply their knowledge to the enduring understandings and learning objectives in the course.

The following table provides examples of questions and instructional strategies for implementing data analysis resources into the course:

Skills	Key Questions	Instructional Notes or Sample Activities	Instructional Strategies
4.A <i>Identify and describe patterns and trends in the data or graph.</i>	<ul style="list-style-type: none"> What does the data or graph show? What trends and patterns can you identify from the data? 	Have students practice identifying and describing trends by assigning a “friends without pens” task. Give students a difficult data set or graph and let them discuss (without writing anything) for a short period of time. Then have students return to their seats and have them fully identify and describe the patterns in the given data or graph.	<ul style="list-style-type: none"> Friends Without Pens Write and Switch Predict and Explain
4.B <i>Demonstrate consistency between different graphical representations of the same physical situation.</i>	<ul style="list-style-type: none"> What physical feature(s) do the representations have in common? How do the representations demonstrate consistency? What would a representation look like if it were inconsistent? What other representations could be created that would also be consistent with the physical situation? How could the current representation be changed to be nontraditional but still be a consistent representation? (For example, a momentum versus time graph could be re-represented as a net force versus time graph.) 	Have students practice demonstrating consistency between graphical representations by doing four-square problem solving. Give students a physical scenario, from the textbook, AP Exam, or other source, and ask them to create four consistent representations that match the physical scenario. Examples of representations include, but are not limited to, sketches, graphs, free-body diagrams, force diagrams, energy bar charts, and momentum bar charts.	<ul style="list-style-type: none"> Four-Square Problem Solving Bar Chart

continued on next page

Skills	Key Questions	Instructional Notes or Sample Activities	Instructional Strategies
<p>4.C <i>Linearize data and/or determine a best fit line or curve.</i></p>	<ul style="list-style-type: none"> ▪ What information is being represented, and what is the relationship between the variables being graphed? ▪ What variables would need to be graphed to create a linear relationship? ▪ What is the physical meaning of the slope and/or area underneath the linearized graph? ▪ What is the physical meaning of the y and/or x intercept of the linearized graph? 	<p>Have students practice linearization whenever possible in laboratory activities, but also provide students practice on equations they have never seen before, including mathematical relationships (e.g., volume of a sphere versus the radius of the sphere), relationships beyond the scope of the course (e.g., magnitude of electric field versus distance from point charge), and even fictional relationships (create fictional equations and have students discuss how the variables could be rearranged to linearize).</p>	<ul style="list-style-type: none"> ▪ Create a Plan ▪ Write and Switch/Graph and Switch
<p>4.D <i>Select relevant features of a graph to describe a physical situation or solve problems.</i></p>	<ul style="list-style-type: none"> ▪ What is the physical meaning of the slope and/or area underneath the graph? ▪ What is the physical meaning of the y and/or x intercept of the graph? ▪ How can the data represented in the graph help to answer the question or solve a problem? ▪ What is the relationship between the information gained from interpreting the graph and the question being asked? 	<p>Have students practice selecting and using relevant features of graphs to describe physical situations or problems by giving them ranking tasks. Ranking tasks with graphs including extraneous information helps students practice sorting through information in graphical form to determine what information and features are relevant to the problem or physical situation.</p>	<ul style="list-style-type: none"> ▪ Ranking ▪ Graph and Switch ▪ Friends Without Pens
<p>4.E <i>Explain how the data or graph illustrates a physics principle, process, concept, or theory.</i></p>	<ul style="list-style-type: none"> ▪ What information or data are being graphed? ▪ What is the relationship between the variables in the graph? ▪ What kinds of claim could be made about the graph? ▪ What evidence from the graph could be used to support the claim? ▪ What physical process, principle, concept, or theory can connect the evidence provided by the graph to the claim? 	<p>Have students practice constructing an argument by giving students graphs or data, and then ask students to construct mathematical arguments either in support of or in opposition to the claim that the graph or data illustrate a given process, concept, or theory.</p>	<ul style="list-style-type: none"> ▪ Construct an Argument ▪ Write and Switch ▪ Conflicting Contentions

Science Practice 5: Theoretical Relationships

Determine the effects on a quantity when another quantity or the physical situation changes.

Physicists commonly use mathematical representations to describe and explain phenomena as well as to solve problems. When students work with these representations, they should understand the connections between the mathematical description, the physical phenomena, and the concepts represented in the mathematical descriptions. When using equations or mathematical representations, students need to be able to justify why using a particular equation to analyze a particular situation is useful, and to be aware of the conditions under which the equations/mathematical representations can be used. Students tend to rely too much on mathematical representations. When solving a problem, they need to be able to describe the problem situation in multiple ways, including pictorial representations, force diagrams, and so forth, and then choose an appropriate mathematical representation instead of first choosing a formula whose variables seem to match the givens in the problem.

Students should be able to work with the algebraic form of the equation before substituting values, and should also be able to evaluate the equation(s) and the answer in terms of units and limiting case analysis. Students should be able to translate between functional relationships in equations (proportionalities, inverse proportionalities, etc.) and cause-and-effect relationships in the physical world. Finally, students are expected to be able to evaluate a numerical result in terms of whether it makes sense. In many physics situations, simple mathematical routines may be needed to arrive at a result even though they are not the focus of a learning objective.

The following table provides examples of questions and instructional strategies for implementing theoretical relationship resources into the course:

Skills	Key Questions	Instructional Notes or Sample Activities	Instructional Strategies
5.A <i>Select an appropriate law, definition, or mathematical relationship or model to describe a physical situation.</i>	<ul style="list-style-type: none"> What clues are given in the problem that can help identify what fundamental physics law, relationship, or equation should be applied to the situation? 	Have students identify which main law, definition, or mathematical relationship should be used based solely on question stems. (AP Physics question prompts are a great source of material.)	<ul style="list-style-type: none"> Write and Switch Working Backward
5.B <i>Determine the relationship between variables within an equation when an existing variable changes.</i>	<ul style="list-style-type: none"> Can the relationship be rewritten so that the variable in question is alone on one side of the equation? What symbols in the relationship are constants versus variables that can change? What potential variables cannot change in this situation? 	<p>Have students practice determining relationships between variables by giving them qualitative reasoning tasks. Present students with a physical situation and ask them to apply a principle to qualitatively reason what will happen.</p> <p>Give students a scenario where a force is being applied on an object and ask them to determine the relationship between net force and acceleration when the mass of the object increases.</p>	<ul style="list-style-type: none"> Qualitative Reasoning Graph and Switch

continued on next page

Skills	Key Questions	Instructional Notes or Sample Activities	Instructional Strategies
5.C <i>Determine the relationship between variables within an equation when a new variable is introduced.</i>	<ul style="list-style-type: none"> What relationship exists between variables originally? How does the introduction of the new variable affect the original relationship? 	Have students practice determining the relationships between variables by using conflicting contentions tasks. Give students an equation and a scenario where a new variable is introduced, and ask two student's opinions on the new relationship after the introduction of the new variable. Have students identify which claim is correct and explain why.	<ul style="list-style-type: none"> Conflicting Contentions Qualitative Reasoning
5.D <i>Determine or estimate the change in a quantity using a mathematical relationship.</i>	<ul style="list-style-type: none"> How can the mathematical relationship be rearranged so the variables in question can be easily recognized and the relationships understood? How can relationships be modified or combined to estimate or calculate values? Is there more than one way to calculate or estimate the quantity needed? 	Have students practice determining the change in a quantity by giving them qualitative reasoning tasks. Present students with a physical situation and ask them to apply a principle to qualitatively reason what will happen. For example, when analyzing the torque applied to a door, students should be able to qualitatively and quantitatively determine and/or estimate the changes in the applied torque depending on the length of the lever arm.	<ul style="list-style-type: none"> Qualitative Reasoning Identify Subtasks
5.E <i>Derive a symbolic expression from known quantities by selecting and following a logical algebraic pathway.</i>	<ul style="list-style-type: none"> What is the fundamental physics principle, law, or relationship that relates to the given physical scenario? How does that fundamental physics principle, law, or relationship combine with given information and/or other physical laws to help derive a logical pathway to the desired solution? 	Have students practice determining symbolic expressions with a write and switch. Ask students to derive an expression and work on it individually for a short period of time. Students then switch papers and share their steps with a partner. Both students receive feedback on their derivation (including whether it follows a logical algebraic pathway) and final symbolic expression.	<ul style="list-style-type: none"> Model Questions Write and Switch

Science Practice 6: Mathematical Routines

Solve problems of physical situations using mathematical relationships.

Students need to be proficient in problem solving and in the application of fundamental principles to a wide variety of situations. Problem-solving abilities can be fostered by scaffolded practice and exposure to a range of challenging problems. In general, the purpose of allowing calculators and equation sheets to be used on both sections of the AP Physics C: Mechanics Exam is to place greater emphasis on the understanding and application of fundamental physical principles and concepts. The availability of equations for all students means that in scoring the exam, little or no credit will be awarded for simply writing down equations. For solving problems, a sophisticated scientific or graphing calculator is no substitute for a thorough grasp of the physics involved. It should be noted that although fewer topics are covered in AP Physics C: Mechanics than in AP Physics 1, they are covered in greater depth and with greater analytical and mathematical sophistication, including calculus applications.

The following table provides examples of questions and instructional strategies for implementing mathematical routine resources into the course:

Skills	Key Questions	Instructional Notes or Sample Activities	Instructional Strategies
6.A <i>Extract quantities from narratives or mathematical relationships to solve problems.</i>	<ul style="list-style-type: none"> What quantities are given? What quantity is needed to answer the question? What relationship(s) link the needed with the given quantities? 	<p>Have students practice extracting quantities from narratives and/or mathematical relationships by giving them working backward tasks. These tasks require students to reason about physical situations in an unusual way and often allow for more than one solution. For example, give students the following equation and ask them to create another representation or a written explanation of the physical scenario.</p> $\mu_s (200\text{kg})(9.8\text{m/s}^2) \cos 30^\circ$ $= (200\text{kg})(9.8\text{m/s}^2) \sin 30^\circ$	<ul style="list-style-type: none"> Working Backward Simplify the Problem
6.B <i>Apply an appropriate law, definition, or mathematical relationship to solve a problem.</i>	<ul style="list-style-type: none"> What laws, definitions, or mathematical relationships exist that relate the given problem? What are the rules, assumptions, or limitations surrounding the use of the chosen law, definition, or relationship? 	<p>Have students practice applying an appropriate law, definition, or mathematical relationship with a write and switch. Ask them to derive an expression or solve a problem, giving them a short amount of time to work on it individually. Students then switch papers and share their steps with a partner. Both students receive feedback on their derivation or problem solution (including whether it follows a logical algebraic pathway).</p>	<ul style="list-style-type: none"> Write and Switch Simplify the Problem Ask the Expert

continued on next page

Skills	Key Questions	Instructional Notes or Sample Activities	Instructional Strategies
<p>6.C Calculate an unknown quantity with units from known quantities by selecting and following a logical computational pathway.</p>	<ul style="list-style-type: none"> ▪ Did the calculation begin with an equation or a fundamental physics relationship, law, or definition? ▪ Are the steps clearly written out and annotated? ▪ Are any steps skipped? ▪ Is the unknown quantity clearly labeled as the final answer complete with units? 	<p>Have students practice calculating unknown quantities from known quantities by assigning them a “What if Anything Is Wrong?” task. These tasks focus a student’s attention on troubleshooting errors and misconceptions by focusing on problems that may arise when they do the same procedures themselves. For example, including a gravitational potential energy relationship of mgh in a mechanical energy calculation of a spaceship orbiting the earth instead of or in addition to the correct gravitational potential energy expression of GmM/R.</p>	<ul style="list-style-type: none"> ▪ “What if Anything Is Wrong?” ▪ Model Questions ▪ Discussion Groups
<p>6.D Assess the reasonableness of results or solutions.</p>	<ul style="list-style-type: none"> ▪ What does “reasonable” mean for a numeric solution? ▪ What does “reasonable” look like for a symbolic solution? ▪ How can a result or solution be double-checked for “reasonableness?” 	<p>Have students practice assessing the reasonableness of a result or solution by assigning them a meaningful, meaningless calculation task. For example, when asked to write an expression for the energy of a system, have students decide which of the following expressions are meaningful. (MgD, Mg/D, MD/g, and $1/MgD$)</p>	<ul style="list-style-type: none"> ▪ Meaningful, Meaningless Calculations ▪ Working Backward

Science Practice 7: Argumentation

Develop an explanation or scientific argument.

A scientific explanation, accounting for an observed phenomenon, needs to be experimentally testable. One should be able to use it to make predictions about new phenomenon. A theory uses a unified approach to account for a large set of phenomena and gives accounts that are consistent with multiple experimental outcomes within the range of applicability of the theory. Examples of theories in physics include the kinetic molecular theory, quantum theory, and atomic theory. Students should understand the difference between explanations and theories.

Students should be prepared to offer evidence, construct reasoned arguments for their claim from the evidence, and use the claim or explanation to make predictions. A prediction states the expected outcome of a particular experimental design based on an explanation or a claim under scrutiny.

Physicists examine data and evidence to develop claims about physical phenomena. As they articulate their claims, physicists use reasoning processes that rely on their awareness of different types of relationships, connections, and patterns within the data and evidence. They then formulate a claim and develop an argument that explains how the claim is supported by the available evidence. AP Physics C: Mechanics teachers should help students learn how to create persuasive and meaningful arguments by improving their proficiency with each of these skills.

The following table provides examples of questions and instructional strategies for implementing argumentation resources into the course:

Skills	Key Questions	Instructional Notes or Sample Activities	Instructional Strategies
7.A <i>Make a scientific claim.</i>	<ul style="list-style-type: none">What possible claims could you make based on the question and the evidence?What claim will you make?What is your purpose (to define, show causality, compare, or explain a process)?What evidence supports your claim?How does the evidence support your claim?	<p>Have students identify and explain the evidence that supports their claim with an emphasis on <i>how</i> the evidence supports the claim.</p> <p>Give students a question, such as, "Which of the following is most responsible for . . ."</p> <p>Students should analyze possibilities and the evidence for and against each position. Have students choose a position and write a defensible claim or thesis that reflects their reasoning and evidence.</p>	<ul style="list-style-type: none">Conflicting Contentions
7.B <i>Support a claim with evidence from experimental data.</i>	<ul style="list-style-type: none">What possible claims could you make based on the question and the evidence?What claim will you make?What is your purpose (to define, show causality, compare, or explain a process)?What evidence supports your claim?How does the evidence support your claim?	<p>Have students identify and explain the experimental data that supports their claim, with an emphasis on <i>how</i> the data supports the claim. This can be practiced by giving students a debriefing activity. After students complete a laboratory activity and collect data, have them meet in groups to discuss the understanding of the data to lead to a consensus on its meaning. This helps clarify misconceptions and deepens the understanding of the relationship between evidence and claim.</p>	<ul style="list-style-type: none">Predict and ExplainDebriefingQuickwrite

continued on next page

Skills	Key Questions	Instructional Notes or Sample Activities	Instructional Strategies
7.C Support a claim with evidence from physical representations.	<ul style="list-style-type: none"> What physical representations are valid in this physical scenario? What physical representation supports your claim? How does the physical representation support your claim? 	Have students identify and explain the evidence from physical representations (graphs, free-body diagrams, etc.) that support their claim with an emphasis on <i>how</i> the reasoning supports the claim.	<ul style="list-style-type: none"> Conflicting Contentions Construct an Argument
7.D Provide reasoning to justify a claim using physical principles or laws.	<ul style="list-style-type: none"> Explain why your evidence supports your claim using a transition such as <i>because</i> or <i>therefore</i>. Question your reasoning. Does it make sense? Have you provided a solid explanation of your reasoning? What reasoning (physical principles or laws) supports your claim? How does the reasoning support your claim? 	<p>Have students identify and state the reasoning that supports their claim with an emphasis on <i>how</i> the reasoning supports the claim.</p> <p>Ask students to “close the loop” and explain <i>why</i> the evidence supports their claim by using reasoning.</p>	<ul style="list-style-type: none"> Desktop Experiment Construct an Argument Write and Switch
7.E Explain the connection between experimental results and larger physical principles, laws, or theories.	<ul style="list-style-type: none"> What is the relationship between the experimental results and physical laws, principles, or theories? What connections are there between the experimental results and physical laws, principles, or theories? Is there more than one fundamental physics principle that can be used to support the experimental results? 	<p>Have students practice explaining connections between experimental results and physics principles by having them practice constructing an argument.</p> <p>Have students create a short paragraph or set of sentences to explain experimental results, and then have them switch papers to review each other’s connections.</p>	<ul style="list-style-type: none"> Qualitative Reasoning Construct an Argument Write and Switch
7.F Explain how potential sources of experimental error may affect results and/or conclusions.	<ul style="list-style-type: none"> What fundamental sources of error exist for the experiment? How can these sources of error be reduced or eliminated? How will each source of error affect the final result of the experiment? 	Have students practice explaining how potential sources of experimental error can affect results by assigning desktop experiment tasks. Present students with a small and simple desktop experiment and be asked to use the apparatus to answer a question and address sources of error.	<ul style="list-style-type: none"> Desktop Experiment Conflicting Contentions Sharing and Responding

THIS PAGE IS INTENTIONALLY LEFT BLANK.

AP PHYSICS C: MECHANICS

Exam Information

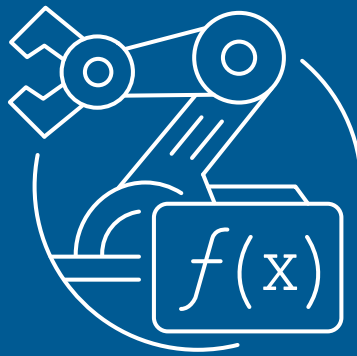

Exam Overview

The AP Physics C: Mechanics Exam assesses student application of the science practices and understanding of the learning objectives outlined in the course framework. The exam is 1 hour and 30 minutes long and includes 35 multiple-choice questions and 3 free-response questions. A four-function, scientific, or graphing calculator is allowed on both sections of the exam. The details of the exam, including exam weighting and timing, can be found below:

Section	Number and Type of Questions	Number of Questions	Weighting	Timing
I	Multiple-choice questions	35	50%	45 minutes
II	Free-response questions (15 points each)	3	50%	45 minutes

The exam assesses content from each of four big ideas for the course:

Big Idea 1: Change

Big Idea 2: Force Interactions

Big Idea 3: Fields

Big Idea 4: Conservation

The exam also assesses each of the seven units of the course with the following weightings of the multiple-choice section of the AP Exam:

Exam Weighting for the Multiple-Choice Section of the AP Exam

Unit of Instruction	Weighting
Unit 1: Kinematics	14–20%
Unit 2: Newton’s Laws of Motion	17–23%
Unit 3: Work, Energy, and Power	14–17%
Unit 4: Systems of Particles and Linear Momentum	14–17%
Unit 5: Rotation	14–20%
Unit 6: Oscillations	6–14%
Unit 7: Gravitation	6–14%

How Student Learning Is Assessed on the AP Exam

The AP Physics C: Mechanics science practices are assessed on the AP Exam in the multiple-choice and free-response sections as detailed below.

Section I: Multiple-Choice

Practices 1, 2, 4, 5, 6, and 7 are assessed in the multiple-choice section with the following weighting (Science Practice 3 will not be assessed in the multiple-choice section):

Exam Weighting for the Multiple-Choice Section of the AP Exam

Science Practices	Weighting
Practice 1: Visual Representations	14–17%
Practice 2: Question and Method	3–6%
Practice 4: Data Analysis	14–17%
Practice 5: Theoretical Relationships	25–34%
Practice 6: Mathematical Routines	14–20%
Practice 7: Argumentation	14–20%

Section II: Free-Response

All of the AP Physics C: Mechanics science practices are assessed in the free-response section with the following weightings:

Exam Weighting for the Free-Response Section of the AP Exam

Science Practices	Weighting
Practice 1: Visual Representations	4–7%
Practice 2: Question and Method	6–11%
Practice 3: Representing Data and Phenomena	13–20%
Practice 4: Data Analysis	8–13%
Practice 5: Theoretical Relationships	20–24%
Practice 6: Mathematical Routines	20–24%
Practice 7: Argumentation	11–18%

One of the three free-response questions will include an experimental or lab-based component.

Task Verbs Used in Free-Response Questions

The following task verbs are commonly used in the free-response questions.

- **Calculate:** Perform mathematical steps to arrive at a final answer, including algebraic expressions, properly substituted numbers, and correct labeling of units and significant figures. Also phrased as “What is?”
- **Compare:** Provide a description or explanation of similarities and/or differences.
- **Derive:** Perform a series of mathematical steps using equations or laws to arrive at a final answer.
- **Describe:** Provide the relevant characteristics of a specified topic.
- **Determine:** Make a decision or arrive at a conclusion after reasoning, observation, or applying mathematical routines (calculations).
- **Estimate:** Roughly calculate numerical quantities, values (greater than, equal to, less than), or signs (negative, positive) of quantities based on experimental evidence or provided data. When making estimations, showing steps in calculations are not required.
- **Explain:** Provide information about how or why a relationship, process, pattern, position, situation, or outcome occurs, using evidence and/or reasoning to support or qualify a claim. Explain “how” typically requires analyzing the relationship, process, pattern, position, situation, or outcome; whereas, explain “why” typically requires analysis of motivations or reasons for the relationship, process, pattern, position, situation, or outcome.
- **Justify:** Provide evidence to support, qualify, or defend a claim, and/or provide reasoning to explain how that evidence supports or qualifies the claim.
- **Label:** Provide labels indicating unit, scale, and/or components in a diagram, graph, model, or representation.
- **Plot:** Draw data points in a graph using a given scale or indicating the scale and units, demonstrating consistency between different types of representations.
- **Sketch/Draw:** Create a diagram, graph, representation, or model that illustrates or explains relationships or phenomena, demonstrating consistency between different types of representations. Labels may or may not be required.

- **State/Indicate/Circle:** Indicate or provide information about a specified topic, without elaboration or explanation. Also phrased as “What...?” or “Would...?” interrogatory questions.
- **Verify:** Confirm that the conditions of a scientific definition, law, theorem, or test are met in order to explain why it applies in a given situation. Also, use empirical data, observations, tests, or experiments to prove, confirm, and/or justify a hypothesis.

Sample Exam Questions

The following are examples of the kinds of multiple-choice questions found on the exam.

Section I: Multiple-Choice Questions

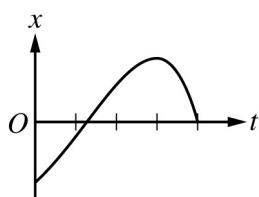

1. The graph shows the position x as a function of time t of an object in linear motion. Which of the following graphs best represents the velocity v of the object as a function of t ?

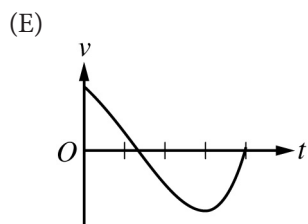
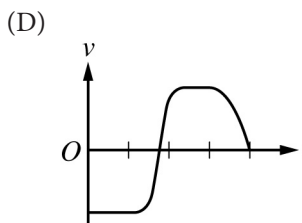
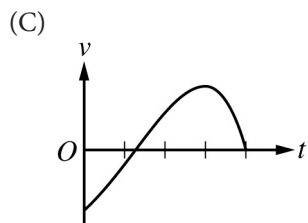
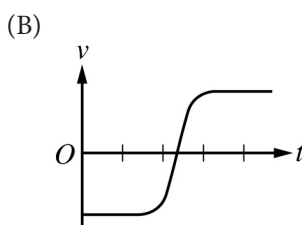
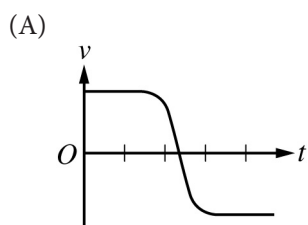

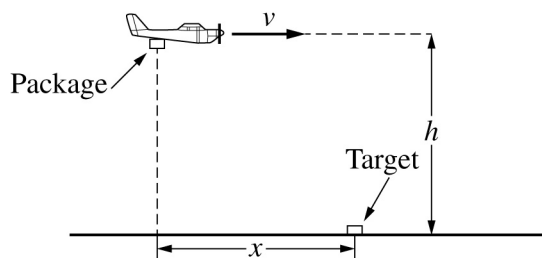

2. A plane is moving horizontally through the sky with speed v . A package is dropped from the plane and travels a horizontal distance x from the point of release to where it lands on a target. If air resistance is negligible, the height from which the package is released is

- (A) $\frac{1}{2}g\sqrt{\frac{x}{v}}$ (B) $\frac{1}{2}gt^2$
 (C) $\frac{1}{2}g\left(\frac{x}{2v}\right)$ (D) $\frac{1}{2}g\left(\frac{x}{v}\right)^2$
 (E) $\frac{1}{2}g\left(\frac{v}{x}\right)^2$

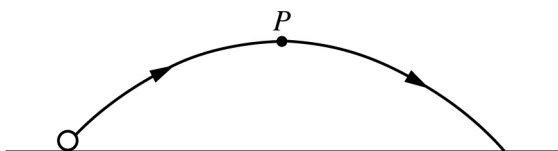

3. A small sphere is thrown through the air and follows the parabolic path shown in the figure. Point P is the highest point the sphere reaches. Assuming air resistance is negligible, which of the following claims is true of the sphere while it is in motion?
- (A) The vertical component of the sphere's velocity is at a maximum at point P .
 (B) The horizontal component of the sphere's velocity is zero at point P .
 (C) The acceleration of the sphere is constant.
 (D) The sphere's speed is constant.
 (E) The displacement of the sphere is zero at point P .



4. The swing shown above is attached to a rope that passes over an ideal pulley and then back down to the hands of a child sitting on the swing. The tensions in the rope on the left and on the right are T_L and T_R , respectively, and the weight of the child plus the swing is W . Which of the following free-body diagrams best shows the child and the swing if they are to remain at rest and in equilibrium?

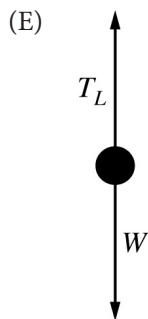
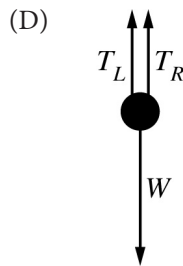
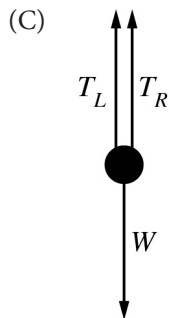
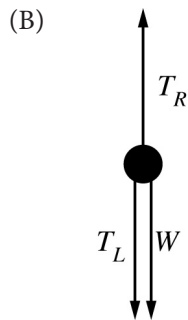
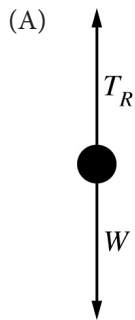

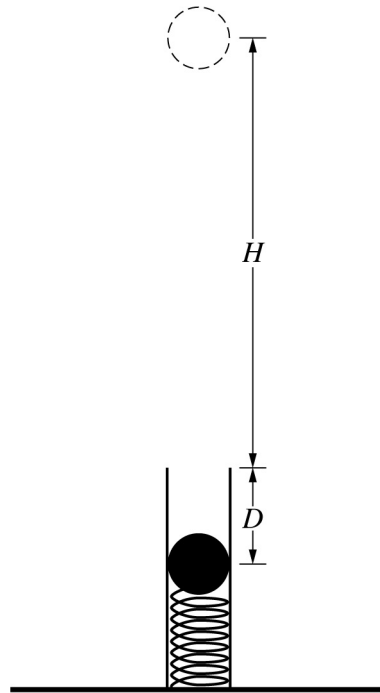

5. An experiment is performed to determine the unknown mass of a sphere. A spring-loaded launcher is used to launch the sphere. The launcher is set to exert a force with an average magnitude of F on the sphere over a distance D . The sphere is launched vertically upward and takes a time t to reach a height H , as shown in the figure. Which of the following gives the minimum data needed to determine the mass of the sphere?
- (A) F only
 (B) F and D only
 (C) F , H , and t
 (D) H , t , and D
 (E) F , D , and H

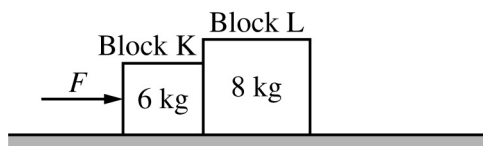

6. Blocks K and L are initially at rest on a horizontal surface of negligible friction. A horizontal force F is exerted on block K , as shown in the figure, and the blocks move to the right with an acceleration of $2 \frac{m}{s^2}$. The magnitude of the force exerted on block K by block L is
- (A) zero
 (B) 2 N
 (C) 12 N
 (D) 16 N
 (E) 28 N

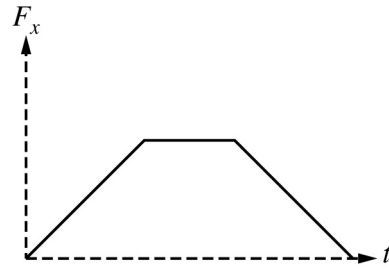

9. An object is moving in a straight line along the x -axis. The net force F_x exerted on the object as a function of time t is shown in the graph. Which of the following could be the momentum p_x of the object as a function of t ?

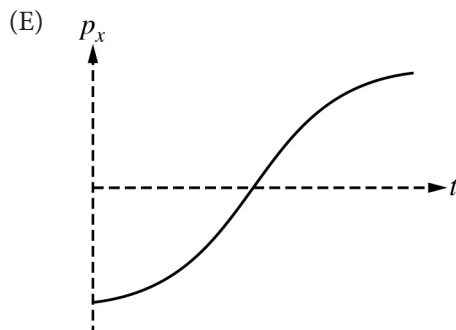
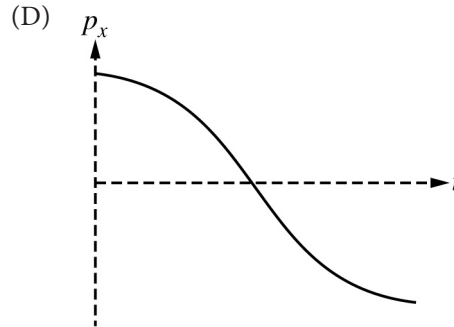
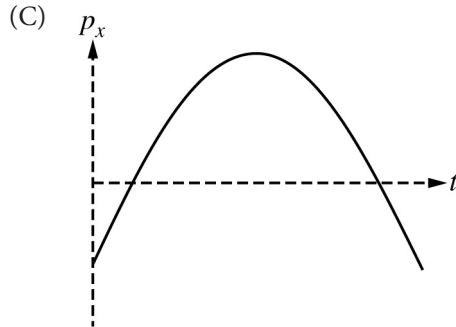
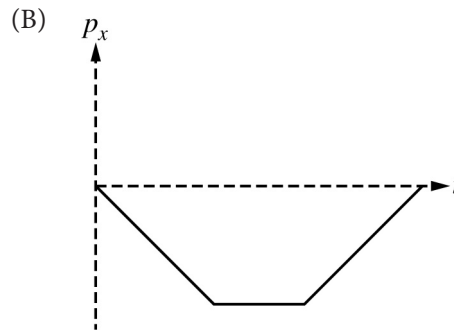
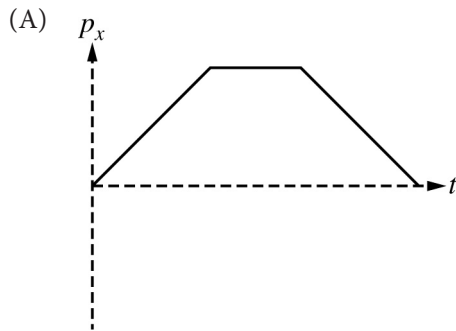

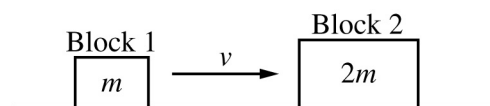

10. Block 1 of mass m is moving with speed v to the right on a horizontal surface of negligible friction, as shown in the figure. Block 1 makes an elastic, head-on collision with block 2 of mass $2m$, which is at rest. Which of the following are correct velocities v_1 and v_2 for blocks 1 and 2, respectively, immediately after the collision?

(A) $v_1 = \frac{1}{3}v$ and $v_2 = \frac{2}{3}v$ (B) $v_1 = -\frac{1}{3}v$ and $v_2 = \frac{2}{3}v$

(C) $v_1 = 0$ and $v_2 = \frac{1}{2}v$ (D) $v_1 = -\frac{1}{2}v$ and $v_2 = \frac{1}{2}v$

(E) $v_1 = \frac{1}{2}v$ and $v_2 = \frac{1}{2}v$

11. A figure skater is spinning with her arms outstretched such that her rotational inertia is I . She is spinning with an angular speed ω_0 . She pulls in her arms such that her rotational inertia reduces to $\frac{1}{3}I$. Her new angular speed will be

(A) $\frac{1}{6}\omega_0$ (B) $\frac{1}{3}\omega_0$

(C) ω_0 (D) $3\omega_0$

(E) $6\omega_0$

12. A wheel of radius 15 cm has a rotational inertia of $2.3 \text{ kg} \cdot \text{m}^2$. The wheel is spinning at a rate of 6.5 revolutions per second. A frictional force is applied tangentially to the wheel to bring it to a stop. The work done by the torque to stop the wheel is most nearly

(A) zero (B) -50 J

(C) -100 J (D) -1920 J

(E) -3840 J

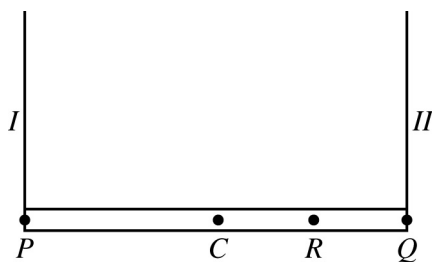

13. A horizontal rod is supported at each end by ropes *I* and *II*, which are attached to the rod at points *P* and *Q*, respectively, as shown in the figure. The two ropes have negligible mass, and the rod has a nonuniform mass distribution such that the rod's center of mass is at point *R*. Point *C* is the center of the rod. The rod remains horizontal. Which of the following vectors could represent the tensions T_I and T_{II} in ropes *I* and *II*, respectively, and the weight W of the rod?

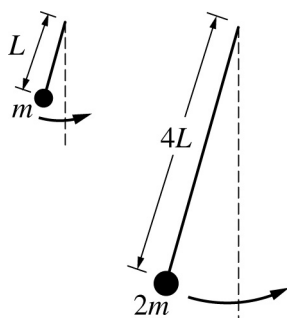
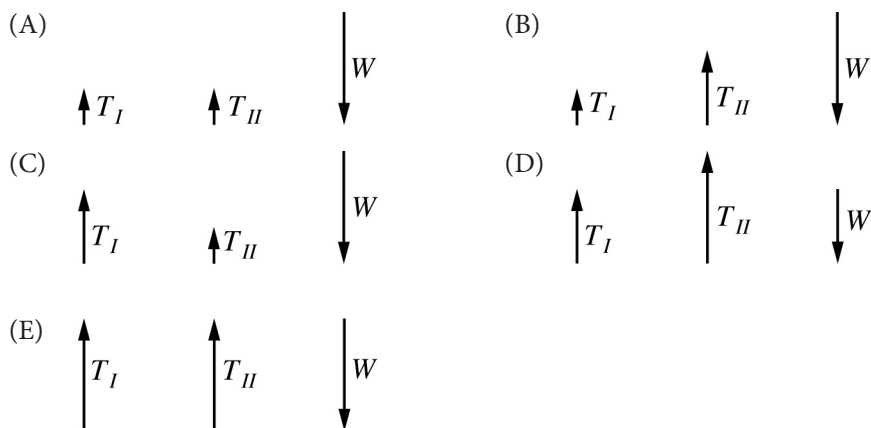

14. A small sphere of mass m is at the end of a light string of length L . The sphere is pulled back a small distance and released. The sphere swings with a period of motion T . The process is repeated with a sphere of mass $2m$ and a light string of length $4L$. The new period of motion will be
- (A) $8T$ (B) $2T$
 (C) $\frac{1}{2}T$ (D) $\frac{1}{4}T$
 (E) $\frac{1}{8}T$

15. The acceleration due to gravity at Earth's surface is g . Astronauts are traveling to another planet that has three times the radius and four times the mass of Earth. The acceleration due to gravity at the surface of the other planet is
- (A) $\frac{4}{9}g$ (B) g
 (C) $\frac{4}{3}g$ (D) $\frac{16}{9}g$
 (E) $\frac{9}{4}g$

Section II: Free-Response Questions

The following are examples of the of free-response questions found on the exam. Note that on the actual AP Exam, there will be three questions.

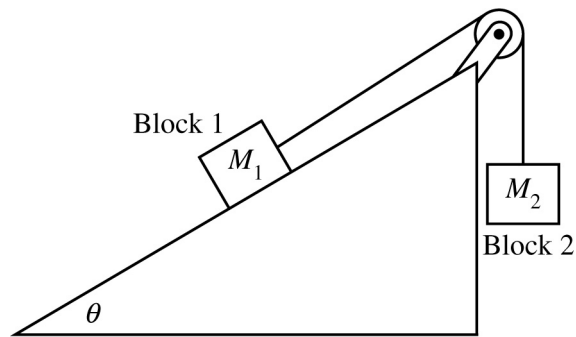

1. Students set up a system of two blocks and an inclined plane, as shown in the figure. Block 1 of mass M_1 is on a surface that is inclined at an angle θ to the horizontal. The friction between block 1 and the surface is negligible. A string is attached to block 1, extends over an ideal pulley, and is then attached to block 2 of mass M_2 .
- (a) In an initial setup, $M_1 = 3M$ and $M_2 = M$. Calculate the value of θ that would allow the system to remain in equilibrium.
- The original inclined plane is now replaced with one that has a rough surface. The coefficients of static and kinetic friction between block 1 and the surface are μ_s and μ_k , respectively. Block 1 is again chosen so that $M_1 = M$.
- (b) Derive an expression for the maximum value of M_2 that would allow this system to remain in equilibrium. Express your answer in terms of M , μ_s , μ_k , and physical constants, as appropriate.
- Block 2 of mass M_2 is now chosen such that block 1 will accelerate up the inclined plane.
- (c)
- Derive an expression for the magnitude of the acceleration of block 1. Express your answer in terms of M_1 , M_2 , μ_s , μ_k , θ , and physical constants, as appropriate.
 - Derive an expression for the tension in the string. Express your answer in terms of M_1 , M_2 , μ_s , μ_k , θ , and physical constants, as appropriate.

- (d) On the axes below, sketch the speed v and distance d moved by block 1 up the inclined plane as functions of time.

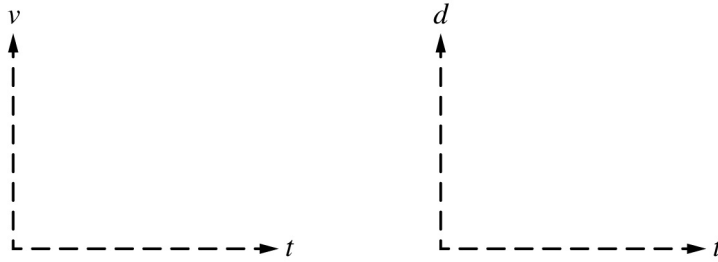

- (e) During the experiments, students collect data that shows the acceleration of the blocks actually increases while the blocks are in motion.
- i. On this axis below, sketch the speed v of block 1 as a function of t .

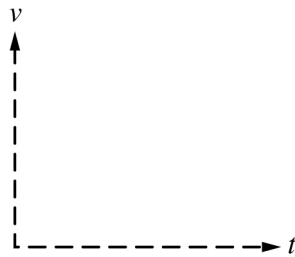

- ii. Explain why the experiment may have produced an increasing acceleration instead of the predicted constant acceleration.

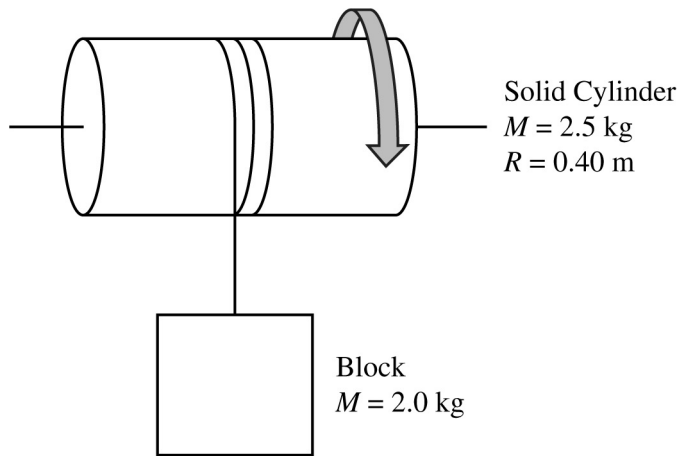

2. A block of mass 2.0 kg is attached to a light string that is wrapped around a solid cylinder, as shown in the figure. The cylinder has a mass of $M = 2.5 \text{ kg}$ and a radius of $R = 0.40 \text{ m}$. The cylinder can rotate with negligible friction about a light rod through its central axis. The block-cylinder system is initially held at rest.
- (a) Using integral calculus, show that the rotational inertia of the cylinder about its central axis is $\frac{1}{2}MR^2$.

- (b) The block is released from rest and the string unwinds, causing the cylinder to rotate on the rod.
- Calculate the linear acceleration of the block.
 - Calculate the net torque exerted on the cylinder.
 - Calculate the tension in the string.

At time t_s , the block reaches its lowest point as the string has completely unwound. The string then begins to rewind on the cylinder, and the mass is raised back upward.

- (c) On the axis below, sketch the angular momentum L of the cylinder as a function of time t from the moment the mass is released to shortly after t_s .

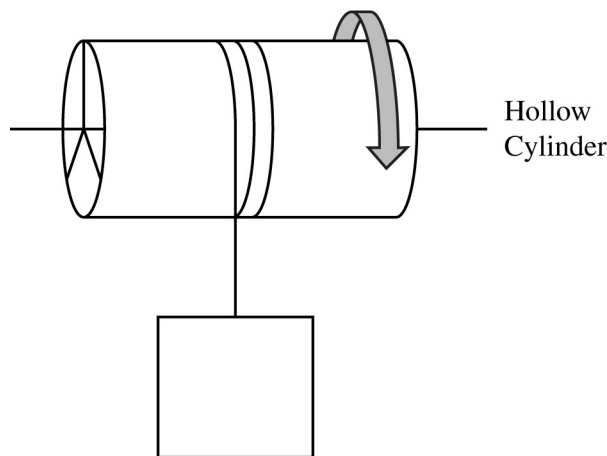
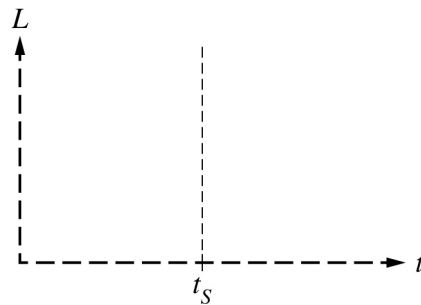

The solid cylinder is replaced by a hollow cylinder with the same mass and radius. Lightweight spokes attach the hollow cylinder to a light rod through its central axis. The hollow cylinder can rotate around its central axis with negligible friction. The string is wound around the hollow cylinder so that the block is at the same initial position as before. The block is again released from rest. The time it takes for the string to completely unwind from the hollow cylinder is t_H .

- (d) Is the time t_H greater than, less than, or equal to the time t_s ?
 _____ Greater than _____ Less than _____ Equal to
 Justify your answer.

Answer Key and Question Alignment to Course Framework

Multiple-Choice Question	Answer	Skill	Learning Objective	Unit
1	A	4.B	CHA-1.C	1
2	D	5.D	CHA-2.C	1
3	C	7.A	CHA-2.C	1
4	D	1.D	INT-3.A	2
5	E	2.C	INT-1.C	2
6	D	6.C	INT-3.A	2
7	A	6.B	INT-4.A	3
8	C	7.D	CON-3.A	3
9	E	4.B	INT-5.D	4
10	B	5.D	CON-4.C	4
11	D	5.B	CON-5.D	5
12	D	6.A	INT-7.D	5
13	B	1.C	INT-6.B	5
14	B	5.B	INT-8.K	6
15	A	5.B	FLD-1.B	7

Free-Response Question	Skill	Learning Objective	Unit
1	3.C, 5.A, 5.D, 6.B, 7.A, 7.D	CHA-1.C, INT-1.B, INT-1.C, INT-3.A, INT-3.B	1, 2, 3
2	3.C, 5.A, 5.D, 5.E, 6.C, 7.A, 7.D	INT-1.C, INT-3.B, INT-6.D, INT-7.A, CON-5.A	1, 2, 3



Scoring Guidelines

Question 1

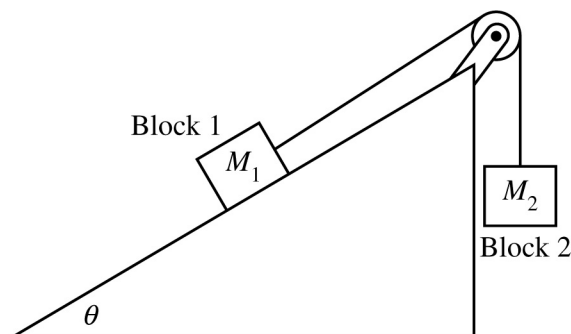

1. Students set up a system of two blocks and an inclined plane, as shown in the figure. Block 1 of mass M_1 is on a surface that is inclined at an angle θ to the horizontal. The friction between block 1 and the surface is negligible. A string is attached to block 1, extends over an ideal pulley, and is then attached to block 2 of mass M_2 .
- (a) In an initial setup, $M_1 = 3M$ and $M_2 = M$. Calculate the value of θ that would allow the system to remain in equilibrium.
- The original inclined plane is now replaced with one that has a rough surface. The coefficients of static and kinetic friction between block 1 and the surface are μ_s and μ_k , respectively. Block 1 is again chosen so that $M_1 = M$.
- (b) Derive an expression for the maximum value of M_2 that would allow this system to remain in equilibrium. Express your answer in terms of M , μ_s , μ_k , and physical constants, as appropriate.
- Block 2 of mass M_2 is now chosen such that block 1 will accelerate up the inclined plane.
- (c)
- Derive an expression for the magnitude of the acceleration of block 1. Express your answer in terms of M_1 , M_2 , μ_s , μ_k , θ , and physical constants, as appropriate.
 - Derive an expression for the tension in the string. Express your answer in terms of M_1 , M_2 , μ_s , μ_k , θ , and physical constants, as appropriate.
- (d) On the axes below, sketch the speed v and distance d moved by block 1 up the inclined plane as functions of time.

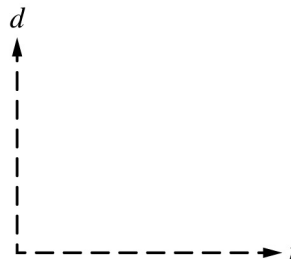
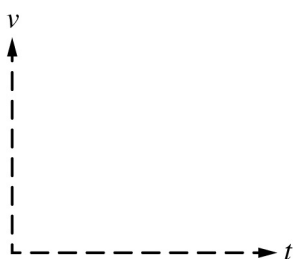

(e) During the experiments, students collect data that shows the acceleration of the blocks actually increases while the blocks are in motion.

i. On this axis below, sketch the speed v of block 1 as a function of t .

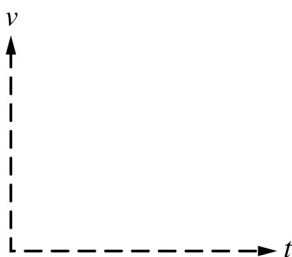

ii. Explain why the experiment may have produced an increasing acceleration instead of the predicted constant acceleration.

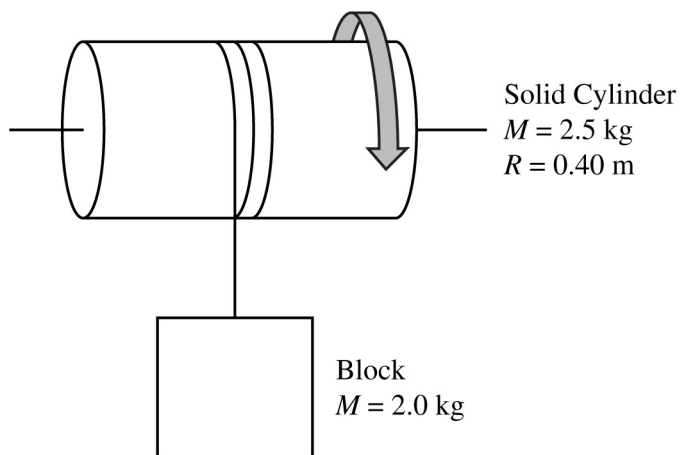

Scoring Guidelines for Question 1

15 points

Learning Objectives: **CHA-1.C** **INT-1.B.a** **INT-1.C.e** **INT-3.A.c** **INT-3.B**

- (a)** Calculate the value of θ that would allow the system to remain in equilibrium. **1 point**
 One point for a correct equation using Newton's second law on the two-block system in equilibrium. **5.A**

$$\sum F = M_1 g \sin \theta - M_2 g = (M_1 + M_2) a = 0$$

One point for a correct substitution into the above equation. **1 point**

$$3Mg \sin \theta - Mg = 0$$

$$\theta = \sin^{-1}\left(\frac{1}{3}\right) = 19.5^\circ$$

Total for Part (a) **2 points**

- (b)** Derive an expression for the maximum value of M_2 that would allow this system to remain in equilibrium. **1 point**
 One point for a correct equation using Newton's second law on the two-block system in equilibrium. **5.A**

$$\sum F = M_2 g - M_1 g \sin \theta - f = (M_1 + M_2) a = 0$$

One point for a correct substitution for friction into the above equation. **1 point**

$$M_2 g = Mg \sin \theta + \mu_s F_N$$

One point for a correct substitution for the normal force into the above equation. **1 point**

$$M_2 g = Mg \sin \theta + \mu_s Mg \cos \theta$$

$$M_2 = M(\sin \theta + \mu_s \cos \theta)$$

Total for Part (b) **3 points**

- (c) i.** Derive an expression for the magnitude of the acceleration of block 1. **1 point**
 One point for a correct substitution for friction into an equation using Newton's second law on the two-block system. **5.A**

$$\sum F = M_2 g - M_1 g \sin \theta - f = (M_1 + M_2) a$$

$$M_2 g - M_1 g \sin \theta - \mu_k F_N = (M_1 + M_2) a$$

One point for a correct substitution for the normal force into the above equation. **1 point**

$$M_2 g - M_1 g \sin \theta - \mu_k M_1 g \cos \theta = (M_1 + M_2) a$$

$$a = \frac{M_2 - M_1(\sin \theta - \mu_k \cos \theta)}{(M_1 + M_2)} g$$

- ii.** Derive an expression for the tension in the string. **1 point**
 One point for a correct expression of Newton's second law for block 2. **5.A**

$$\sum F = M_2 g - T = M_2 a$$

One point for substituting the answer from part (c)(i) for the acceleration into the above equation. **1 point**

$$T = M_2(g - a)$$

$$T = M_2 \left(g - \frac{M_2 - M_1(\sin \theta - \mu_k \cos \theta)}{(M_1 + M_2)} g \right) = M_2 g \left(1 - \frac{M_2 - M_1(\sin \theta - \mu_k \cos \theta)}{(M_1 + M_2)} \right)$$

Total for Part (c) **4 points**

(d) Sketch the speed v and distance d moved by block 1 up the inclined plane as functions of time.

1 point

One point for indicating that both the speed and the distance increase with time.

3.C

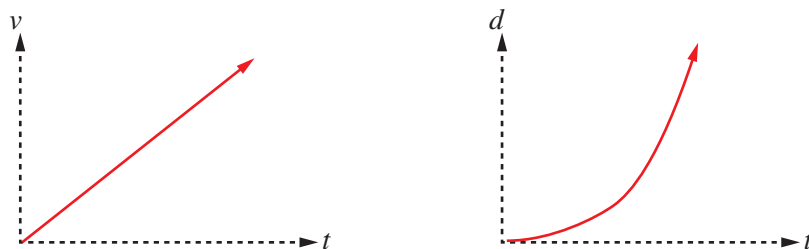

One point for a straight line with a positive slope for the v - t graph.

1 point

3.C

One point for a concave up curve for the d - t graph.

1 point

3.C

Total for Part (d)

3 points

(e) i. On this axis provided, sketch the speed v of block 1 as a function of t .

1 point

One point for a concave up curve for the v - t graph.

3.C

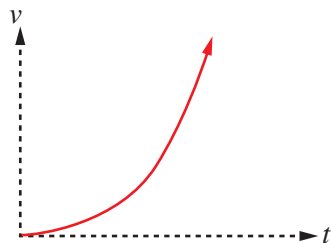

ii. Explain why the experiment may have produced an increasing acceleration instead of the predicted constant acceleration.

1 point

7.A

One point for providing evidence to support the claim (The incline is smoother).

Example of acceptable evidence:

- The block's acceleration increases.
- The net force on the block increases.
- Greater friction indicates a rougher surface; less friction indicates a smoother surface.

One point for correct reasoning.

1 point

7.D

Example of acceptable reasoning:

- The increase in the block's acceleration would indicate a smaller resistive force; thus, friction would be less which would be indicative of a smoother surface.

Example of acceptable explanation (claim, evidence, and reasoning):

- *The block's acceleration would increase if the top part of the incline is smoother than the bottom part. A smoother surface would result in a decrease in friction and an increase in the net force exerted on the block; thus, the block's acceleration would increase.*

Total for part (e)

3 points

Total for Question 1

15 points

Question 2

2. A block of mass 2.0 kg is attached to a light string that is wrapped around a solid cylinder, as shown in the figure. The cylinder has a mass of $M = 2.5\text{ kg}$ and a radius of $R = 0.40\text{ m}$. The cylinder can rotate with negligible friction about a light rod through its central axis. The block-cylinder system is initially held at rest.

- Using integral calculus, show that the rotational inertia of the cylinder about its central axis is $\frac{1}{2}MR^2$.
- The block is released from rest and the string unwinds, causing the cylinder to rotate on the rod.
 - Calculate the linear acceleration of the block.
 - Calculate the net torque exerted on the cylinder.
 - Calculate the tension in the string.

At time t_S , the block reaches its lowest point as the string has completely unwound. The string then begins to rewind on the cylinder, and the mass is raised back upward.

- On the axis below, sketch the angular momentum L of the cylinder as a function of time t from the moment the mass is released to shortly after t_S .

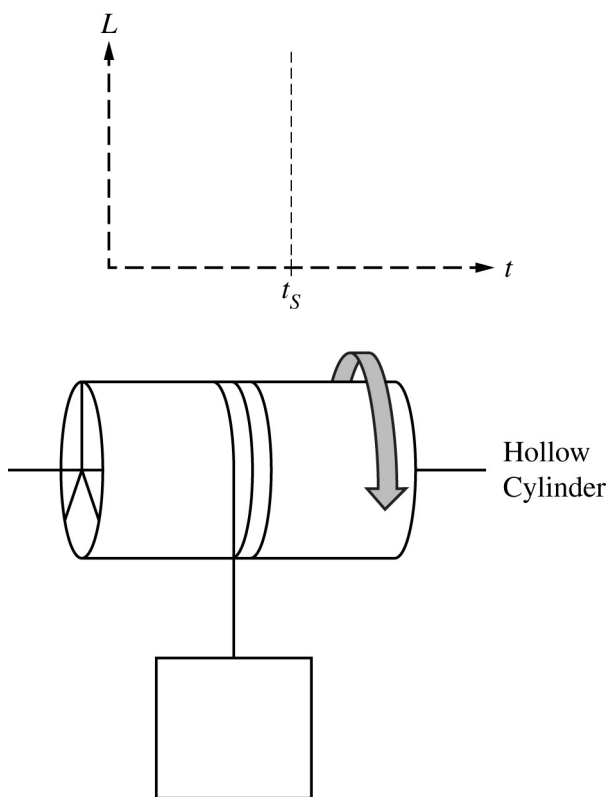

The solid cylinder is replaced by a hollow cylinder with the same mass and radius. Lightweight spokes attach the hollow cylinder to a light rod through its central axis. The hollow cylinder can rotate around its central axis with negligible friction. The string is wound around the hollow cylinder so that the block is at the same initial position as before. The block is again released from rest. The time it takes for the string to completely unwind from the hollow cylinder is t_H .

- Is the time t_H greater than, less than, or equal to the time t_S ?
 _____ Greater than _____ Less than _____ Equal to
 Justify your answer.

Scoring Guidelines for Question 2

15 points

Learning Objectives: INT-1.C.e INT-3.B INT-6.D.e INT-7.A.b CON-5.A.b

- (a) Using integral calculus, show that the rotational inertia of the cylinder about its central axis is $\frac{1}{2}MR^2$. **1 point**
5.A

One point for using the integral form of the rotational inertia equation.

$$I = \int r^2 dm$$

$$V = \pi r^2 L = \frac{m}{\rho}$$

$$dm = 2\rho\pi r L dr$$

One point for a correct substitution for dm into the above equation. **1 point**

$$I = \int r^2 (2\rho\pi r L dr) = 2\rho\pi L \int r^3 dr$$

One point for integrating with correct limits or constant of integration. **1 point**

$$I = 2\rho\pi L \int_{r=0}^{r=R} r^3 dr = 2\left(\frac{M}{\pi R^2 L}\right)\pi L \left[\frac{1}{4}r^4\right]_{r=0}^{r=R} = \left(\frac{2M}{R^2}\right)\left(\frac{R^4}{4}\right) = \frac{1}{2}MR^2$$

Total for Part (a) 3 points

- (b) i. Calculate the linear acceleration of the block. **1 point**
5.A

One point for a correctly substituting into the linear form of Newton's second law on the block.

$$\sum F = Mg - T = Ma$$

One point for a correctly substituting into the rotational form of Newton's second law on the cylinder. **1 point**

$$\sum \tau = Fr_{\perp} = TR = I\alpha = \left(\frac{1}{2}MR^2\right)\left(\frac{a}{R}\right)$$

$$T = \frac{1}{2}Ma$$

One point for a correct expression of Newton's second law on the block-cylinder system. **1 point**

$$Mg - \left(\frac{1}{2}Ma\right) = Ma$$

$$Mg = \frac{3}{2}Ma$$

$$a = \frac{2}{3}g = \frac{2}{3}\left(9.8 \frac{\text{m}}{\text{s}^2}\right) = 6.5 \frac{\text{m}}{\text{s}^2}$$

- ii. Calculate the net torque exerted on the cylinder. **1 point**

One point for correctly substituting the answer from part (b) into the rotational form of Newton's second law on the cylinder. **5.D**

$$\sum \tau = \left(\frac{1}{2}MR^2\right)\left(\frac{a}{R}\right) = \left(\frac{1}{2}MR\right)\left(\frac{2}{3}g\right) = \frac{1}{3}MgR$$

One point for substitution into the above equation. **1 point**

$$\tau = \left(\frac{1}{3}\right)(2.5 \text{ kg})\left(9.8 \frac{\text{m}}{\text{s}^2}\right)(0.40 \text{ m}) = 3.27 \text{ N}\cdot\text{m}$$

- iii. Calculate the tension in the string. **1 point**

One point for substitution consistent with answer from (b)(i) into an equation to solve for tension. **6.C**

$$T = \frac{1}{2}Ma = \left(\frac{1}{2}\right)(2.5 \text{ kg})\left(6.5 \frac{\text{m}}{\text{s}^2}\right) = 8.12 \text{ N}$$

Total for Part (b) 6 points

- (c) On the axis provided, sketch the angular momentum L of the cylinder as a function of time t from the moment the mass is released to shortly after t_S . **1 point**
3.C
- One point for indicating that the linear momentum increases before t_S and decreases after t_S .

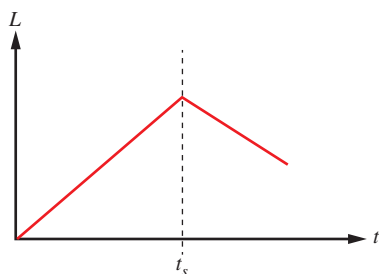

One point for a straight line with a positive slope for before t_S . **1 point**
3.C

One point for a straight line with a negative slope for after t_S . **1 point**
3.C

Total for Part (c) 3 points

- (d) Is the time t_H greater than, less than, or equal to the time t_S ? **1 point**
7.A
- One point for selecting "Greater than".

One point for a correct justification that includes an indication that the rotational inertia is greater for the hollow cylinder than the solid sphere. **1 point**
7.D

One point for a correct justification that connects an increase in rotational inertia to both a decrease in acceleration and an increase of the time of fall. **1 point**
7.D

Example of acceptable justification:

- *The hollow cylinder has more mass toward the outside of the cylinder; thus, it has a greater rotational inertia. Therefore, the acceleration decreases, and the time of fall increases.*

Total for Part (d) 3 points

Total for Question 2 15 points

THIS PAGE IS INTENTIONALLY LEFT BLANK.

AP PHYSICS C: MECHANICS

Appendix

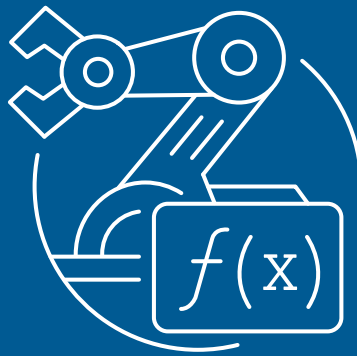

AP PHYSICS C: MECHANICS

Table of Information: Equations

ADVANCED PLACEMENT PHYSICS C TABLE OF INFORMATION

CONSTANTS AND CONVERSION FACTORS

Proton mass, $m_p = 1.67 \times 10^{-27}$ kg Neutron mass, $m_n = 1.67 \times 10^{-27}$ kg Electron mass, $m_e = 9.11 \times 10^{-31}$ kg Avogadro's number, $N_0 = 6.02 \times 10^{23}$ mol ⁻¹ Universal gas constant, $R = 8.31$ J/(mol·K) Boltzmann's constant, $k_B = 1.38 \times 10^{-23}$ J/K	Electron charge magnitude, $e = 1.60 \times 10^{-19}$ C 1 electron volt, $1 \text{ eV} = 1.60 \times 10^{-19}$ J Speed of light, $c = 3.00 \times 10^8$ m/s Universal gravitational constant, $G = 6.67 \times 10^{-11}$ (N·m ²)/kg ² Acceleration due to gravity at Earth's surface, $g = 9.8$ m/s ²
1 unified atomic mass unit, Planck's constant, Vacuum permittivity, Coulomb's law constant, $k = 1/(4\pi\epsilon_0) = 9.0 \times 10^9$ (N·m ²)/C ² Vacuum permeability, Magnetic constant, $k' = \mu_0/(4\pi) = 1 \times 10^{-7}$ (T·m)/A 1 atmosphere pressure,	$1 \text{ u} = 1.66 \times 10^{-27}$ kg = 931 MeV/c ² $h = 6.63 \times 10^{-34}$ J·s = 4.14 × 10 ⁻¹⁵ eV·s $hc = 1.99 \times 10^{-25}$ J·m = 1.24 × 10 ³ eV·nm $\epsilon_0 = 8.85 \times 10^{-12}$ C ² /(N·m ²) $\mu_0 = 4\pi \times 10^{-7}$ (T·m)/A $1 \text{ atm} = 1.0 \times 10^5$ N/m ² = 1.0 × 10 ⁵ Pa

UNIT SYMBOLS	meter, m	mole, mol	watt, W	farad, F
	kilogram, kg	hertz, Hz	coulomb, C	tesla, T
	second, s	newton, N	volt, V	degree Celsius, °C
	ampere, A	pascal, Pa	ohm, Ω	electron volt, eV
	kelvin, K	joule, J	henry, H	

PREFIXES		
Factor	Prefix	Symbol
10 ⁹	giga	G
10 ⁶	mega	M
10 ³	kilo	k
10 ⁻²	centi	c
10 ⁻³	milli	m
10 ⁻⁶	micro	μ
10 ⁻⁹	nano	n
10 ⁻¹²	pico	p

VALUES OF TRIGONOMETRIC FUNCTIONS FOR COMMON ANGLES							
θ	0°	30°	37°	45°	53°	60°	90°
sin θ	0	1/2	3/5	$\sqrt{2}/2$	4/5	$\sqrt{3}/2$	1
cos θ	1	$\sqrt{3}/2$	4/5	$\sqrt{2}/2$	3/5	1/2	0
tan θ	0	$\sqrt{3}/3$	3/4	1	4/3	$\sqrt{3}$	∞

The following assumptions are used in this exam.

- I. The frame of reference of any problem is inertial unless otherwise stated.
- II. The direction of current is the direction in which positive charges would drift.
- III. The electric potential is zero at an infinite distance from an isolated point charge.
- IV. All batteries and meters are ideal unless otherwise stated.
- V. Edge effects for the electric field of a parallel plate capacitor are negligible unless otherwise stated.

ADVANCED PLACEMENT PHYSICS C EQUATIONS

MECHANICS	ELECTRICITY AND MAGNETISM
$v_x = v_{x0} + a_x t$ $x = x_0 + v_{x0} t + \frac{1}{2} a_x t^2$ $v_x^2 = v_{x0}^2 + 2a_x(x - x_0)$ $\vec{a} = \frac{\sum \vec{F}}{m} = \frac{\vec{F}_{net}}{m}$ $\vec{F} = \frac{d\vec{p}}{dt}$ $\vec{J} = \int \vec{F} dt = \Delta\vec{p}$ $\vec{p} = m\vec{v}$ $ \vec{F}_f \leq \mu \vec{F}_N $ $\Delta E = W = \int \vec{F} \cdot d\vec{r}$ $K = \frac{1}{2} m v^2$ $P = \frac{dE}{dt}$ $P = \vec{F} \cdot \vec{v}$ $\Delta U_g = mg\Delta h$ $a_c = \frac{v^2}{r} = \omega^2 r$ $\vec{\tau} = \vec{r} \times \vec{F}$ $\vec{\alpha} = \frac{\sum \vec{\tau}}{I} = \frac{\vec{\tau}_{net}}{I}$ $I = \int r^2 dm = \sum mr^2$ $x_{cm} = \frac{\sum m_i x_i}{\sum m_i}$ $v = r\omega$ $\vec{L} = \vec{r} \times \vec{p} = I\vec{\omega}$ $K = \frac{1}{2} I\omega^2$ $\omega = \omega_0 + \alpha t$ $\theta = \theta_0 + \omega_0 t + \frac{1}{2} \alpha t^2$	$a = \text{acceleration}$ $E = \text{energy}$ $F = \text{force}$ $f = \text{frequency}$ $h = \text{height}$ $I = \text{rotational inertia}$ $J = \text{impulse}$ $K = \text{kinetic energy}$ $k = \text{spring constant}$ $\ell = \text{length}$ $L = \text{angular momentum}$ $m = \text{mass}$ $P = \text{power}$ $p = \text{momentum}$ $r = \text{radius or distance}$ $T = \text{period}$ $t = \text{time}$ $U = \text{potential energy}$ $v = \text{velocity or speed}$ $W = \text{work done on a system}$ $x = \text{position}$ $\mu = \text{coefficient of friction}$ $\theta = \text{angle}$ $\tau = \text{torque}$ $\omega = \text{angular speed}$ $\alpha = \text{angular acceleration}$ $\phi = \text{phase angle}$ $\vec{F}_s = -k\Delta\vec{x}$ $U_s = \frac{1}{2} k(\Delta x)^2$ $x = x_{max} \cos(\omega t + \phi)$ $T = \frac{2\pi}{\omega} = \frac{1}{f}$ $T_s = 2\pi\sqrt{\frac{m}{k}}$ $T_p = 2\pi\sqrt{\frac{\ell}{g}}$ $ \vec{F}_G = \frac{Gm_1 m_2}{r^2}$ $U_G = -\frac{Gm_1 m_2}{r}$
$ \vec{F}_E = \frac{1}{4\pi\epsilon_0} \left \frac{q_1 q_2}{r^2} \right $ $\vec{E} = \frac{\vec{F}_E}{q}$ $\oint \vec{E} \cdot d\vec{A} = \frac{Q}{\epsilon_0}$ $E_x = -\frac{dV}{dx}$ $\Delta V = -\int \vec{E} \cdot d\vec{r}$ $V = \frac{1}{4\pi\epsilon_0} \sum_i \frac{q_i}{r_i}$ $U_E = qV = \frac{1}{4\pi\epsilon_0} \frac{q_1 q_2}{r}$ $\Delta V = \frac{Q}{C}$ $C = \frac{\kappa\epsilon_0 A}{d}$ $C_p = \sum_i C_i$ $\frac{1}{C_s} = \sum_i \frac{1}{C_i}$ $I = \frac{dQ}{dt}$ $U_C = \frac{1}{2} Q\Delta V = \frac{1}{2} C(\Delta V)^2$ $R = \frac{\rho\ell}{A}$ $\vec{E} = \rho\vec{J}$ $I = Nev_d A$ $I = \frac{\Delta V}{R}$ $R_s = \sum_i R_i$ $\frac{1}{R_p} = \sum_i \frac{1}{R_i}$ $P = I\Delta V$	$A = \text{area}$ $B = \text{magnetic field}$ $C = \text{capacitance}$ $d = \text{distance}$ $E = \text{electric field}$ $\mathcal{E} = \text{emf}$ $F = \text{force}$ $I = \text{current}$ $J = \text{current density}$ $L = \text{inductance}$ $\ell = \text{length}$ $n = \text{number of loops of wire per unit length}$ $N = \text{number of charge carriers per unit volume}$ $P = \text{power}$ $Q = \text{charge}$ $q = \text{point charge}$ $R = \text{resistance}$ $r = \text{radius or distance}$ $t = \text{time}$ $U = \text{potential or stored energy}$ $V = \text{electric potential}$ $v = \text{velocity or speed}$ $\rho = \text{resistivity}$ $\Phi = \text{flux}$ $\kappa = \text{dielectric constant}$ $\vec{F}_M = q\vec{v} \times \vec{B}$ $\oint \vec{B} \cdot d\vec{\ell} = \mu_0 I$ $d\vec{B} = \frac{\mu_0}{4\pi} \frac{I d\vec{\ell} \times \hat{r}}{r^2}$ $\vec{F} = \int I d\vec{\ell} \times \vec{B}$ $B_s = \mu_0 n I$ $\Phi_B = \int \vec{B} \cdot d\vec{A}$ $\mathcal{E} = \oint \vec{E} \cdot d\vec{\ell} = -\frac{d\Phi_B}{dt}$ $\mathcal{E} = -L \frac{dI}{dt}$ $U_L = \frac{1}{2} L I^2$

ADVANCED PLACEMENT PHYSICS C EQUATIONS

GEOMETRY AND TRIGONOMETRY

Rectangle

$$A = bh$$

Triangle

$$A = \frac{1}{2}bh$$

Circle

$$A = \pi r^2$$

$$C = 2\pi r$$

$$s = r\theta$$

Rectangular Solid

$$V = \ell wh$$

Cylinder

$$V = \pi r^2 \ell$$

$$S = 2\pi r \ell + 2\pi r^2$$

Sphere

$$V = \frac{4}{3}\pi r^3$$

$$S = 4\pi r^2$$

Right Triangle

$$a^2 + b^2 = c^2$$

$$\sin \theta = \frac{a}{c}$$

$$\cos \theta = \frac{b}{c}$$

$$\tan \theta = \frac{a}{b}$$

A = area

C = circumference

V = volume

S = surface area

b = base

h = height

ℓ = length

w = width

r = radius

s = arc length

θ = angle

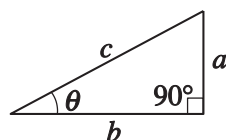
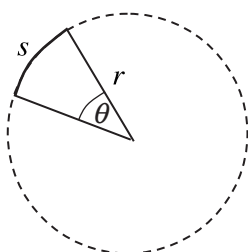

CALCULUS

$$\frac{df}{dx} = \frac{df}{du} \frac{du}{dx}$$

$$\frac{d}{dx}(x^n) = nx^{n-1}$$

$$\frac{d}{dx}(e^{ax}) = ae^{ax}$$

$$\frac{d}{dx}(\ln ax) = \frac{1}{x}$$

$$\frac{d}{dx}[\sin(ax)] = a \cos(ax)$$

$$\frac{d}{dx}[\cos(ax)] = -a \sin(ax)$$

$$\int x^n dx = \frac{1}{n+1} x^{n+1}, n \neq -1$$

$$\int e^{ax} dx = \frac{1}{a} e^{ax}$$

$$\int \frac{dx}{x+a} = \ln|x+a|$$

$$\int \cos(ax) dx = \frac{1}{a} \sin(ax)$$

$$\int \sin(ax) dx = -\frac{1}{a} \cos(ax)$$

VECTOR PRODUCTS

$$\vec{A} \cdot \vec{B} = AB \cos \theta$$

$$|\vec{A} \times \vec{B}| = AB \sin \theta$$

